

Kanlux

KANLUX OFIS LED

Idealne połączenie
efektywnego
oświetlenia
z nowoczesnym
wzornictwem

Funkcjonalne i energooszczędne
rozwiązanie pozwalające skutecznie
oświetlić każdą przestrzeń biurową.



Kanlux
FACTORY

Kanlux

Kanlux OFIS LED

Profesjonalnie i skutecznie

Oprawa z rastrem, dzięki szerokiemu zakresowi parametrów i niskiemu współczynnikowi oślnienia, jest szczególnie polecana do oświetlania biurowych stanowisk pracy, zapewniając optymalne warunki w każdym oświetlanym wnętrzu.



5 LAT GWARANCJI NA WARUNKACH
OŚWIADCZENIA GWARANCYJNEGO
DOSTĘPNEGO NA STRONIE INTERNETOWEJ

Kanlux

**OPCJONALNIE
STEROWANIE
DALI I CASAMBI
READY**

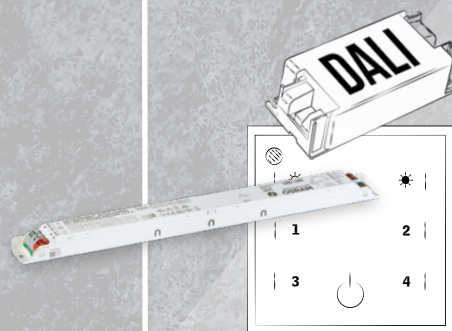

**MOŻLIWOŚĆ MODYFIKACJI
WEDŁUG PREFERENCJI
UŻYTKOWNIKA**



OFIS LED

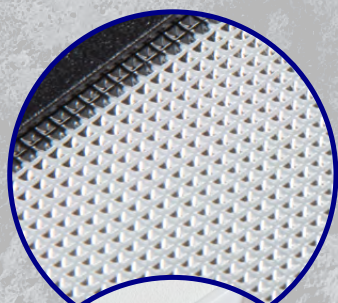

**NOWA GENERACJA
DYFUZORA POPRAWIAJĄCEGO
SKUTECZNOŚĆ ŚWIETLNA
OPRAWY**

**MARKOWE
DIODY
I ZASILACZE**



Kanlux

WERSJA NATYNKOWA

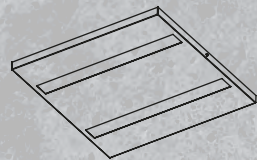

N1 600mm x 600mm



N3 1200mm x 300mm

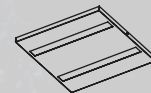

N4 300mm x 300mm

WERSJA PODTYNKOWA

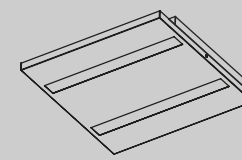

P1 595mm x 595mm

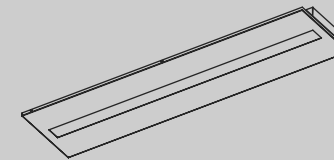

P3 1195mm x 295mm

5 WERSJI

OS MPRM

2 BARWY ŚWIECENIA
ORAZ OPCJA
TUNABLE WHITE



4000K



3000K



WW NW CW

2 KOLORY OBUDOWY
Dyfuzor
mikropryzmatyczny.

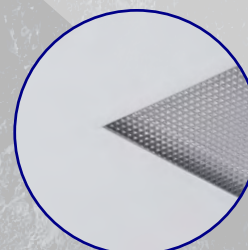

biały

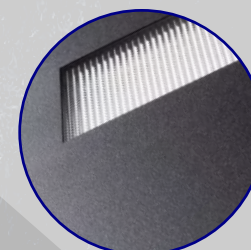

czarny

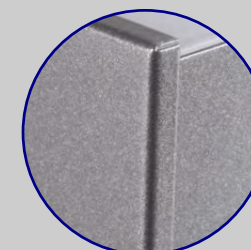

 RAL



Kanlux

WERSJA NATYNKOWA

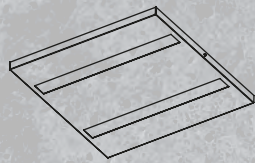

N1 600mm x 600mm



N3 1200mm x 300mm

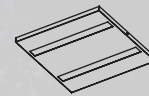

N4 300mm x 300mm

WERSJA PODTYNKOWA

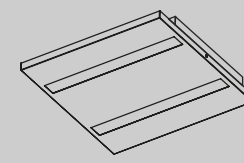

P1 595mm x 595mm

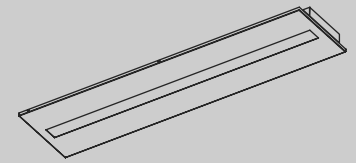

P3 1195mm x 295mm

5 WERSJI

low UGR
Niski współczynnik ośnienia UGR

OS RST

2 WERSJE
OPTYKI



Soczewka o kącie 60°



Soczewka o kącie 90°

3 BARWY ŚWIECENIA
ORAZ OPCJA
TUNABLE WHITE



4000K



3500K



3000K



WW NW CW

2 KOLORY OBUDOWY
Możliwość mieszania kolorystyki rastrów z obudową.



biały



czarny



Kanlux

WERSJA PODTYNKOWA

P1 595mm x 595mm

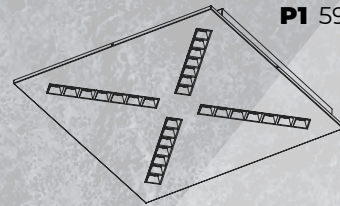

1 WERSJA

low
UGR

Niski
współczynnik
ośnienia UGR

OS RX

2 WERSJE
OPTYKI



60°

Soczewka
o kącie 60°



90°

Soczewka
o kącie 90°

3 BARWY ŚWIECENIA
ORAZ OPCJA
TUNABLE WHITE



4000K



3500K



3000K



WW NW CW

2 KOLORY OBUDOWY

Możliwość mieszania
kolorystyki rastrów
z obudową.



biały



czarny

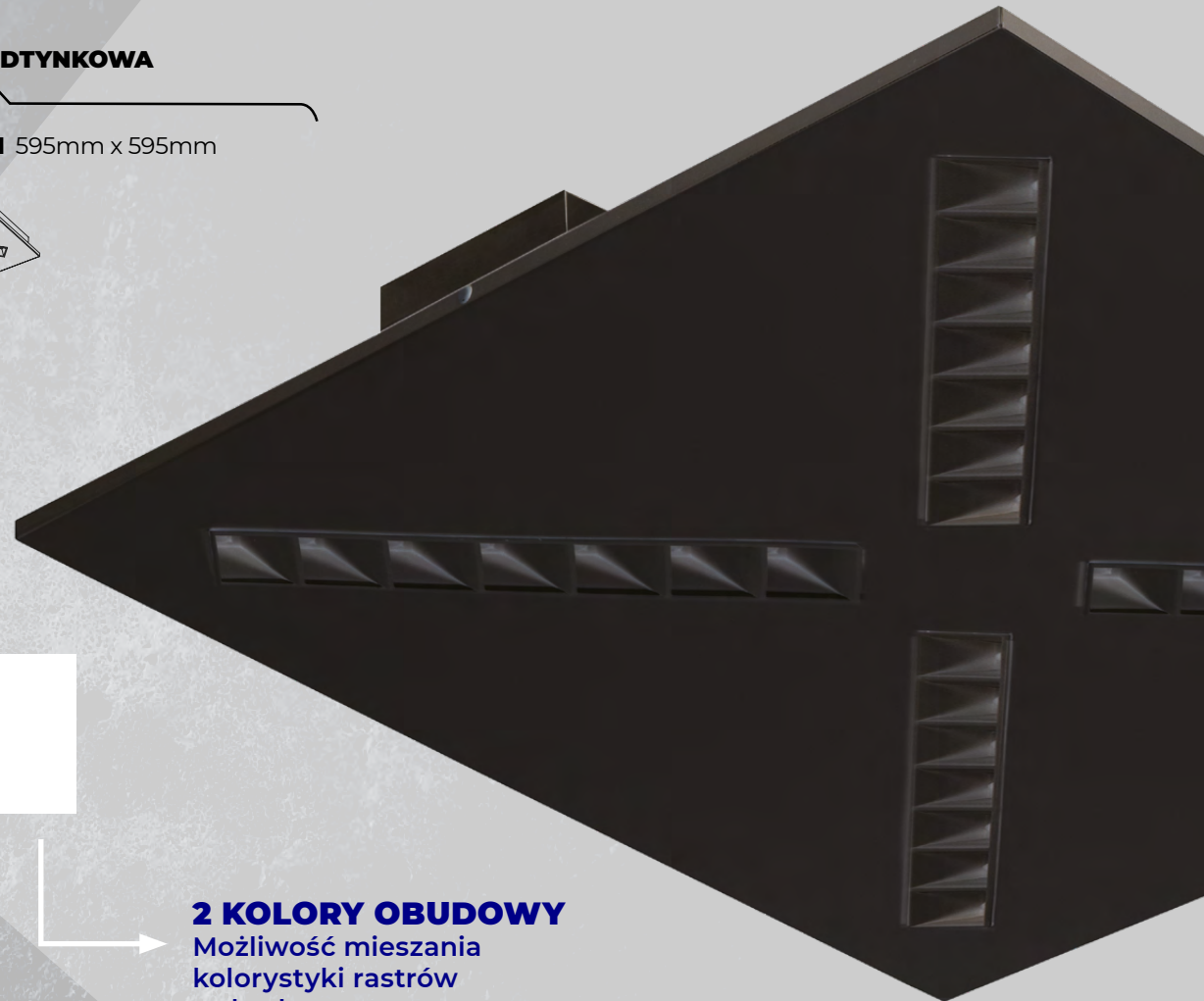

Kanlux

WERSJE SPECJALNE

OFIS LED

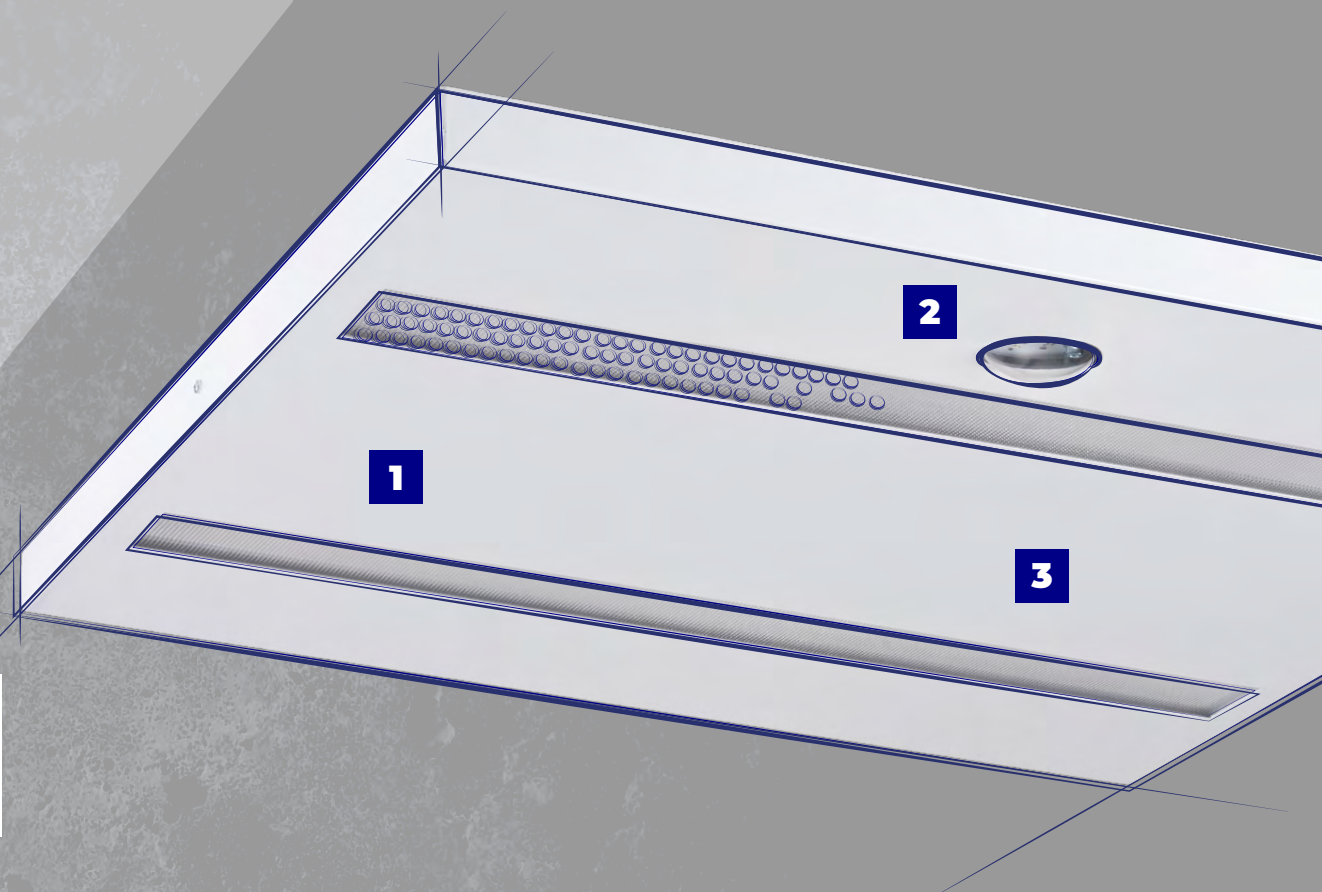

1

**WYKONANIE Z MIKROFALOWYM
CZUJNIKIEM RUCHU
I MOŻLIWOŚCIĄ PODŁĄCZENIA
ZESPOŁU OPRAW**



2

**WYKONANIE AWARYJNE
W OŚMIU RÓŻNYCH
STANDARDACH
Z CERTYFIKATEM CNBOP**

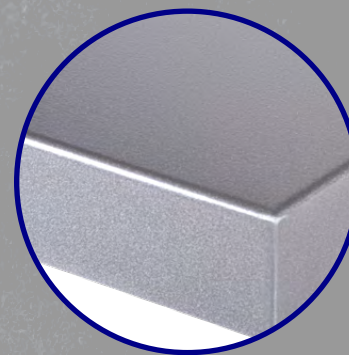

3

**MOŻLIWOŚĆ DOPASOWANIA
DO NAJBARDZIEJ WYMAGAJĄCYCH
KLIENTÓW** (przykład lakierowania
w kolorze DB703)

Kanlux

Kanlux OFIS LED wersja natynkowa

N1 wersja 600x600mm

N3 wersja 300x1200mm

N4 wersja 300x300mm

RÓWNIŻ W WERSJI
ZE STEROWANIEM
DALI



OFIS S LED ... NT ... N1



OFIS S LED ... NT ... N4

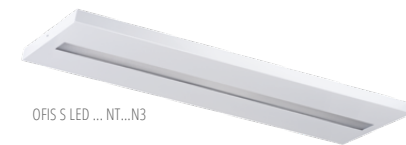

OFIS S LED ... NT...N3

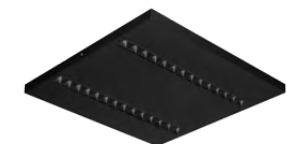

OFIS RST LED ... NT ... N1

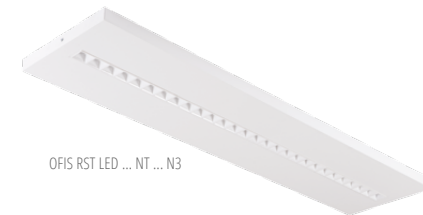

OFIS RST LED ... NT ... N3

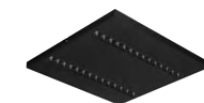

OFIS RST LED ... NT ... N4



ZOBACZ
PEŁNĄ
OFERTĘ

Kanlux

Kanlux OFIS LED wersja podtynkowa

P1 wersja 595x595mm

P3 wersja 295x1190mm

RÓWNIEŻ W WERSJI
ZE STEROWANIEM

DALI



OFIS S LED ... PT ... P1



OFIS S LED ... PT ... P3



OFIS S LED ... PT ... P1

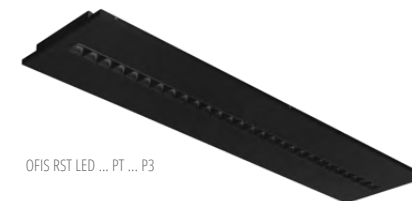

OFIS RST LED ... PT ... P3



OFIS RX LED ... PT ... P1



ZOBACZ
PEŁNĄ
OFERTĘ

Kanlux

Wybierz swoje

OFIS LED

OS	OFIS LED
OSD	OFIS LED DALI
OSC	OFIS LED CASAMBI READY

nazwa rodziny

WW	3000K Ra ≥ 80
WN	3500K Ra ≥ 80
NW	4000K Ra ≥ 80

barwa światła

W	biały white
B	czarny black
WB	biały/czarny white/black
BW	czarny/biały black/white

kolor obudowy

SE	czujnik ruchu motion sensor
AW	moduł awaryjny emergency module

opcje

OS-M5D-WW-RST-B-P3-SE

moc

kąt światła

dyfuzor

rodzaj montażu



S	22W	3200/2800lm
L	31W	4300/3800lm
M	32W	5400/4800lm
H	49W	6300/5600lm

5D	60°
8D	90°

RST	raster liniowy linear raster type
RX	raster poprzeczny cross raster type
MPRM	klosz mikropryzmatyczny microprismatic lampshade

N1	wersja natynkowa surface-mounted	600x600mm
N3	wersja natynkowa surface-mounted	300x1200mm
N4	wersja natynkowa surface-mounted	300x300mm
P1	wersja podtynkowa recessed mounted	595x595mm
P3	wersja podtynkowa recessed mounted	1195x295mm

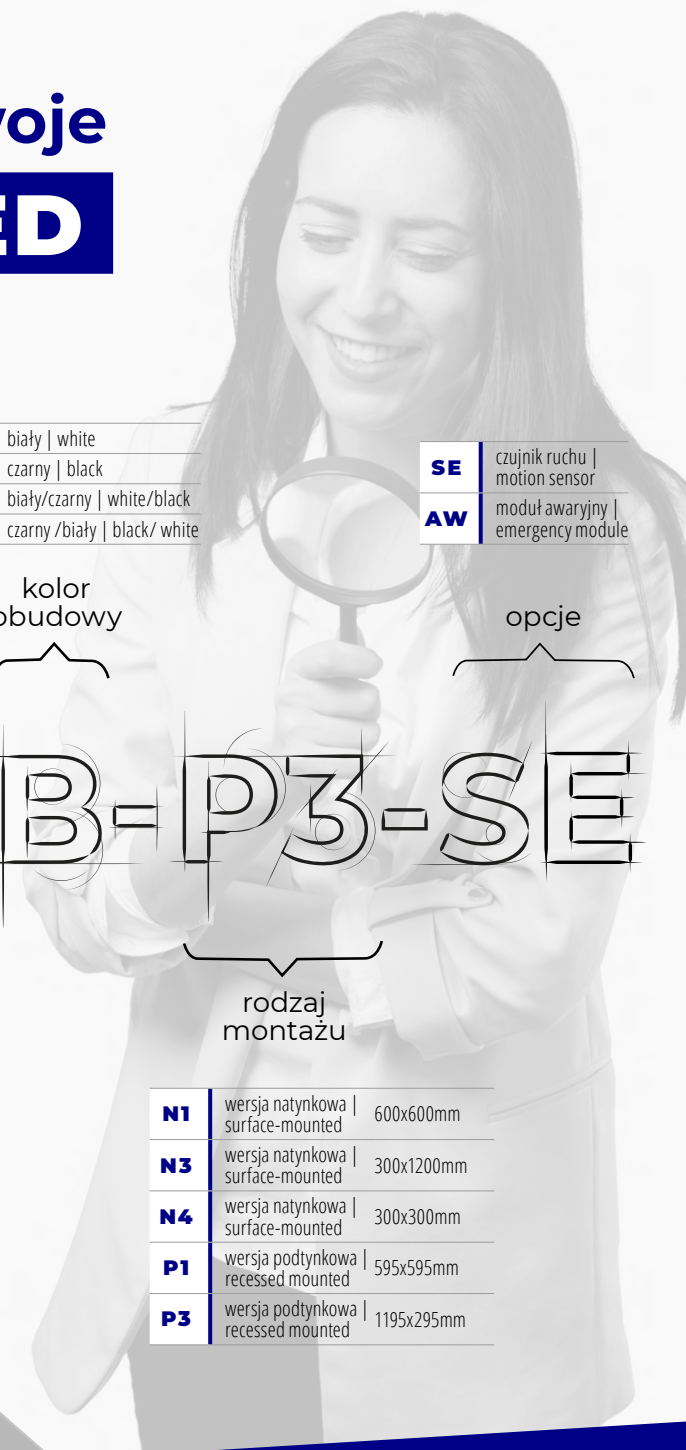

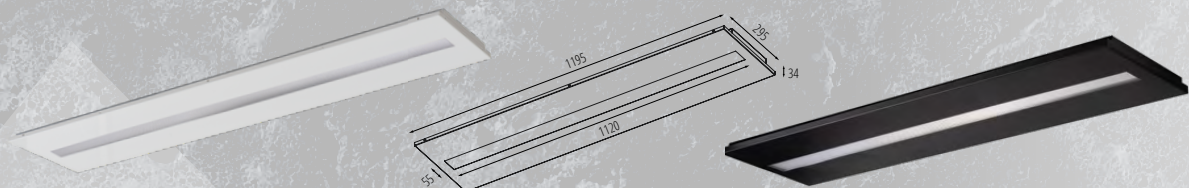
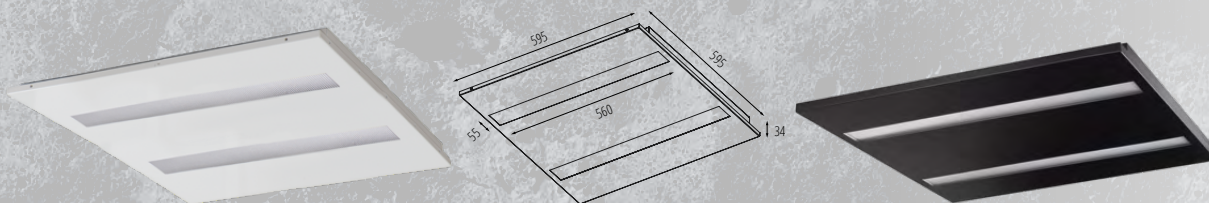
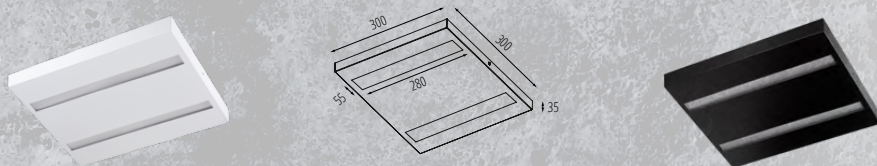
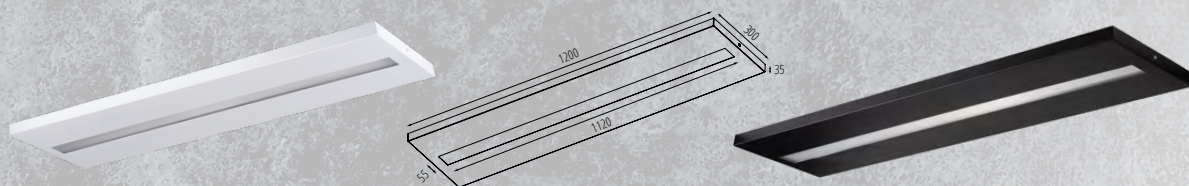
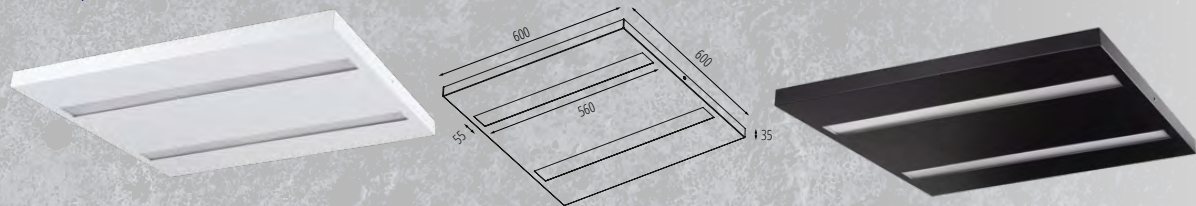

OS MPRM N1 600x600mm

BIALY	35732	OS 40W-830-MPRM-W-N1	4200	40	100	3000K
	32820	OS 40W-840-MPRM-W-N1	4600	40	100	4000K
CZARNY	35729	OS 40W-830-MPRM-B-N1	4100	40	100	3000K
	32824	OS 40W-840-MPRM-B-N1	4300	40	100	4000K
BIALY	36394	OSD 40W-830-MPRM-W-N1	4200	40	100	3000K
	36402	OSD 40W-840-MPRM-W-N1	4600	40	100	4000K
CZARNY	36390	OSD 40W-830-MPRM-B-N1	4100	40	100	3000K
	36398	OSD 40W-840-MPRM-B-N1	4300	40	100	4000K

OS MPRM N3 1200x300mm

BIALY	35733	OS 40W-830-MPRM-W-N3	4100	40	100	3000K
	32821	OS 40W-840-MPRM-W-N3	4500	40	100	4000K
CZARNY	32819	OS 40W-830-MPRM-B-N3	4000	40	100	3000K
	32825	OS 40W-840-MPRM-B-N3	4400	40	100	4000K
BIALY	36395	OSD 40W-830-MPRM-W-N3	4100	40	100	3000K
	36403	OSD 40W-840-MPRM-W-N3	4500	40	100	4000K
CZARNY	36391	OSD 40W-830-MPRM-B-N3	4000	40	100	3000K
	36399	OSD 40W-840-MPRM-B-N3	4400	40	100	4000K

OS MPRM N4 300x300mm

BIALY	38151	OS-18W-830-MPRM-W-N4	2050	18	100	3000K
	38150	OS-18W-840-MPRM-W-N4	2250	18	100	4000K
CZARNY	38155	OS-18W-830-MPRM-B-N4	2000	18	100	3000K
	38154	OS-18W-840-MPRM-B-N4	2200	18	100	4000K
BIALY	38153	OSD-18W-830-MPRM-W-N4	2050	18	100	3000K
	38152	OSD-18W-840-MPRM-W-N4	2250	18	100	4000K
CZARNY	38157	OSD-18W-830-MPRM-B-N4	2000	18	100	3000K
	38156	OSD-18W-840-MPRM-B-N4	2200	18	100	4000K

OS MPRM P1 595x595mm

BIALY	35734	OS 40W-830-MPRM-W-P1	4200	40	100	3000K
	32822	OS 40W-840-MPRM-W-P1	4600	40	100	4000K
CZARNY	35730	OS 40W-830-MPRM-B-P1	4100	40	100	3000K
	32826	OS 40W-840-MPRM-B-P1	4300	40	100	4000K
BIALY	36396	OSD 40W-830-MPRM-W-P1	4200	40	100	3000K
	32828	OSD 40W-840-MPRM-W-P1	4600	40	100	4000K
CZARNY	36392	OSD 40W-830-MPRM-B-P1	4100	40	100	3000K
	36400	OSD 40W-840-MPRM-B-P1	4300	40	100	4000K

OS MPRM P3 1195x295mm

BIALY	35735	OS 40W-830-MPRM-W-P3	4100	40	100	3000K
	32823	OS 40W-840-MPRM-W-P3	4500	40	100	4000K
CZARNY	35731	OS 40W-830-MPRM-B-P3	4000	40	100	3000K
	32827	OS 40W-840-MPRM-B-P3	4400	40	100	4000K
BIALY	36397	OSD 40W-830-MPRM-W-P3	4100	40	100	3000K
	36404	OSD 40W-840-MPRM-W-P3	4500	40	100	4000K
CZARNY	36393	OSD 40W-830-MPRM-B-P3	4000	40	100	3000K
	36401	OSD 40W-840-MPRM-B-P3	4400	40	100	4000K

Kanlux OFIS LED RST N1

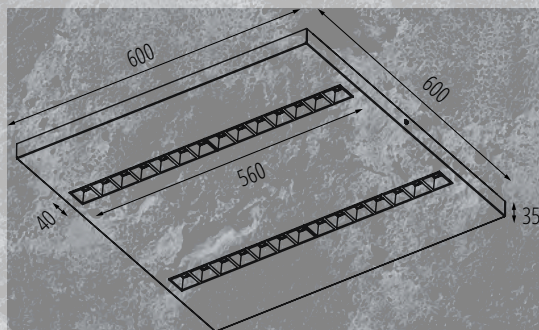
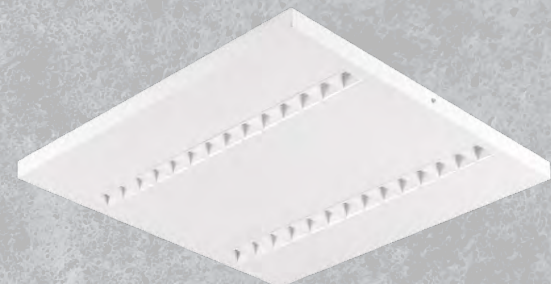

OS RST N1 600x600mm



			3050	22	60	3000
BIAŁY	35810	OS-S5D-WW-RST-W-N1	3050	22	60	3000
	35842	OS-S8D-WW-RST-W-N1	3050	22	90	3000
	36066	OS-S5D-WN-RST-W-N1	3150	22	60	3500
	36082	OS-S8D-WN-RST-W-N1	3150	22	90	3500
	35826	OS-S5D-NW-RST-W-N1	3250	22	60	4000
CZARNY	35858	OS-S8D-NW-RST-W-N1	3250	22	90	4000
	35938	OS-S5D-WW-RST-B-N1	2750	22	60	3000
	35970	OS-S8D-WW-RST-B-N1	2750	22	90	3000
	36130	OS-S5D-WN-RST-B-N1	2800	22	60	3500
	36146	OS-S8D-WN-RST-B-N1	2800	22	90	3500
BIAŁY	35954	OS-S5D-NW-RST-B-N1	2850	22	60	4000
	35986	OS-S8D-NW-RST-B-N1	2850	22	90	4000
	35814	OS-L5D-WW-RST-W-N1	4200	31	60	3000
	35846	OS-L8D-WW-RST-W-N1	4200	31	90	3000
	36070	OS-L5D-WN-RST-W-N1	4250	31	60	3500
CZARNY	36086	OS-L8D-WN-RST-W-N1	4250	31	90	3500
	35830	OS-L5D-NW-RST-W-N1	4300	31	60	4000
	35862	OS-L8D-NW-RST-W-N1	4300	31	90	4000
	35942	OS-L5D-WW-RST-B-N1	3750	31	60	3000
	35974	OS-L8D-WW-RST-B-N1	3750	31	90	3000
BIAŁY	36134	OS-L5D-WN-RST-B-N1	3800	31	60	3500
	36150	OS-L8D-WN-RST-B-N1	3800	31	90	3500
	35958	OS-L5D-NW-RST-B-N1	3850	31	60	4000
	35990	OS-L8D-NW-RST-B-N1	3850	31	90	4000
	35818	OS-M5D-WW-RST-W-N1	5250	39	60	3000
CZARNY	35850	OS-M8D-WW-RST-W-N1	5250	39	90	3000
	36074	OS-M5D-WN-RST-W-N1	4300	39	60	3500
	36090	OS-M8D-WN-RST-W-N1	5300	39	90	3500
	35834	OS-M5D-NW-RST-W-N1	5400	39	60	4000
	35866	OS-M8D-NW-RST-W-N1	5400	39	90	4000
BIAŁY	35946	OS-M5D-WW-RST-B-N1	4650	39	60	3000
	35978	OS-M8D-WW-RST-B-N1	4650	39	90	3000
	36138	OS-M5D-WN-RST-B-N1	4700	39	60	3500
	36154	OS-M8D-WN-RST-B-N1	4700	39	90	3500
	35962	OS-M5D-NW-RST-B-N1	4800	39	60	4000
CZARNY	35994	OS-M8D-NW-RST-B-N1	4800	39	90	4000
	35822	OS-H5D-WW-RST-W-N1	5950	49	60	3000
	35854	OS-H8D-WW-RST-W-N1	5950	49	90	3000
	36078	OS-H5D-WN-RST-W-N1	5350	49	60	3500
	36094	OS-H8D-WN-RST-W-N1	6100	49	90	3500
BIAŁY	35838	OS-H5D-NW-RST-W-N1	6250	49	60	4000
	35870	OS-H8D-NW-RST-W-N1	6250	49	90	4000
	35950	OS-H5D-WW-RST-B-N1	5300	49	60	3000
	35982	OS-H8D-WW-RST-B-N1	5300	49	90	3000
	36142	OS-H5D-WN-RST-B-N1	5450	49	60	3500
CZARNY	36158	OS-H8D-WN-RST-B-N1	5450	49	90	3500
	35966	OS-H5D-NW-RST-B-N1	5600	49	60	4000
	35998	OS-H8D-NW-RST-B-N1	5600	49	90	4000

OS DALI RST N1 600x600mm



			3050	23	60	3000
BIAŁY	35874	OSD-S5D-WW-RST-W-N1	3050	23	60	3000
	35906	OSD-S8D-WW-RST-W-N1	3050	23	90	3000
	36098	OSD-S5D-WN-RST-W-N1	3150	23	60	3500
	36114	OSD-S8D-WN-RST-W-N1	3150	23	90	3500
	35890	OSD-S5D-NW-RST-W-N1	3250	23	60	4000
CZARNY	35922	OSD-S8D-NW-RST-W-N1	3250	23	90	4000
	36002	OSD-S5D-WW-RST-B-N1	2750	23	60	3000
	36034	OSD-S8D-WW-RST-B-N1	2750	23	90	3000
	36162	OSD-S5D-WN-RST-B-N1	2800	23	60	3500
	36178	OSD-S8D-WN-RST-B-N1	2800	23	90	3500
BIAŁY	36018	OSD-S5D-NW-RST-B-N1	2850	23	60	4000
	36050	OSD-S8D-NW-RST-B-N1	2850	23	90	4000
	35878	OSD-L5D-WW-RST-W-N1	4200	32	60	3000
	35910	OSD-L8D-WW-RST-W-N1	4200	32	90	3000
	36102	OSD-L5D-WN-RST-W-N1	4250	32	60	3500
CZARNY	36118	OSD-L8D-WN-RST-W-N1	4250	32	90	3500
	35894	OSD-L5D-NW-RST-W-N1	4300	32	60	4000
	35926	OSD-L8D-NW-RST-W-N1	4300	32	90	4000
	36006	OSD-L5D-WW-RST-B-N1	3750	32	60	3000
	36038	OSD-L8D-WW-RST-B-N1	3750	32	90	3000
BIAŁY	36166	OSD-L5D-WN-RST-B-N1	3800	32	60	3500
	36182	OSD-L8D-WN-RST-B-N1	3800	32	90	3500
	36022	OSD-L5D-NW-RST-B-N1	3850	32	60	4000
	36054	OSD-L8D-NW-RST-B-N1	3850	32	90	4000
	35882	OSD-M5D-WW-RST-W-N1	5250	40	60	3000
CZARNY	35914	OSD-M8D-WW-RST-W-N1	5250	40	90	3000
	36106	OSD-M5D-WN-RST-W-N1	5300	40	60	3500
	36122	OSD-M8D-WN-RST-W-N1	5300	40	90	3500
	35898	OSD-M5D-NW-RST-W-N1	5400	40	60	4000
	35930	OSD-M8D-NW-RST-W-N1	5400	40	90	4000
BIAŁY	36010	OSD-M5D-WW-RST-B-N1	4650	40	60	3000
	36042	OSD-M8D-WW-RST-B-N1	4650	40	90	3000
	36170	OSD-M5D-WN-RST-B-N1	4700	40	60	3500
	36186	OSD-M8D-WN-RST-B-N1	4700	40	90	3500
	36026	OSD-M5D-NW-RST-B-N1	4800	40	60	4000
CZARNY	36058	OSD-M8D-NW-RST-B-N1	4800	40	90	4000
	35886	OSD-H5D-WW-RST-W-N1	5950	50	60	3000
	35918	OSD-H8D-WW-RST-W-N1	5950	50	90	3000
	36110	OSD-H5D-WN-RST-W-N1	6100	50	60	3500
	36126	OSD-H8D-WN-RST-W-N1	6100	50	90	3500
BIAŁY	35902	OSD-H5D-NW-RST-W-N1	6250	50	60	4000
	35934	OSD-H8D-NW-RST-W-N1	6250	50	90	4000
	36014	OSD-H5D-WW-RST-B-N1	5300	50	60	3000
	36046	OSD-H8D-WW-RST-B-N1	5300	50	90	3000
	36174	OSD-H5D-WN-RST-B-N1	5450	50	60	3500
CZARNY	36190	OSD-H8D-WN-RST-B-N1	5450	50	90	3500
	36030	OSD-H5D-NW-RST-B-N1	5600	50	60	4000
	36062	OSD-H8D-NW-RST-B-N1	5600	50	90	4000

Kanlux OFIS LED RST P1

P1

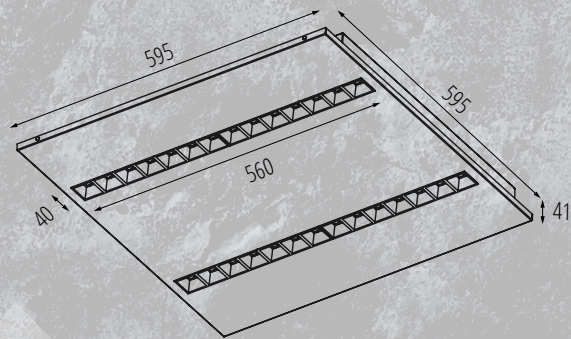
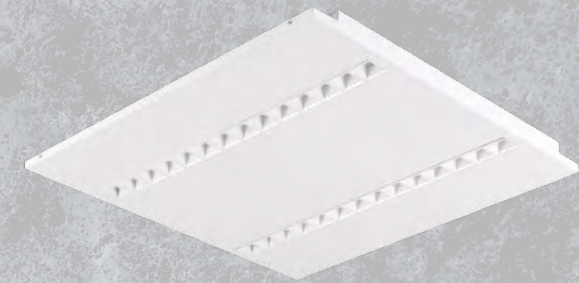

OS RST P1 595x595mm



			lm	lm	°	W
BIAŁY	35812	OS-S5D-WW-RST-W-P1	3050	22	60	3000
	35844	OS-S8D-WW-RST-W-P1	3050	22	90	3000
	36068	OS-S5D-WN-RST-W-P1	3150	22	60	3500
	36084	OS-S8D-WN-RST-W-P1	3150	22	90	3500
	35828	OS-S5D-NW-RST-W-P1	3250	22	60	4000
35860	OS-S8D-NW-RST-W-P1	3250	22	90	4000	
35940	OS-S5D-WW-RST-B-P1	2750	22	60	3000	
35972	OS-S8D-WW-RST-B-P1	2750	22	90	3000	
36132	OS-S5D-WN-RST-B-P1	2800	22	60	3500	
36148	OS-S8D-WN-RST-B-P1	2800	22	90	3500	
35956	OS-S5D-NW-RST-B-P1	2850	22	60	4000	
35988	OS-S8D-NW-RST-B-P1	2850	22	90	4000	
35816	OS-L5D-WW-RST-W-P1	4200	31	60	3000	
35848	OS-L8D-WW-RST-W-P1	4200	31	90	3000	
36072	OS-L5D-WN-RST-W-P1	4250	31	60	3500	
36088	OS-L8D-WN-RST-W-P1	4250	31	90	4000	
35832	OS-L5D-NW-RST-W-P1	4300	31	60	4000	
35864	OS-L8D-NW-RST-W-P1	4300	31	90	4000	
35944	OS-L5D-WW-RST-B-P1	3750	31	60	3000	
35976	OS-L8D-WW-RST-B-P1	3750	31	90	3000	
36136	OS-L5D-WN-RST-B-P1	3800	31	60	3000	
36152	OS-L8D-WN-RST-B-P1	3800	31	90	4000	
35960	OS-L5D-NW-RST-B-P1	3850	31	60	4000	
35992	OS-L8D-NW-RST-B-P1	3850	31	90	4000	
35820	OS-M5D-WW-RST-W-P1	5250	39	60	3000	
35852	OS-M8D-WW-RST-W-P1	5250	39	90	3000	
36076	OS-M5D-WN-RST-W-P1	5300	39	60	3000	
36092	OS-M8D-WN-RST-W-P1	5300	39	90	4000	
35836	OS-M5D-NW-RST-W-P1	5400	39	60	4000	
35868	OS-M8D-NW-RST-W-P1	5400	39	90	4000	
35948	OS-M5D-WW-RST-B-P1	4650	39	60	3000	
35980	OS-M8D-WW-RST-B-P1	4650	39	90	3000	
36140	OS-M5D-WN-RST-B-P1	4700	39	60	3000	
36156	OS-M8D-WN-RST-B-P1	4700	39	90	4000	
35964	OS-M5D-NW-RST-B-P1	4800	39	60	4000	
35996	OS-M8D-NW-RST-B-P1	4800	39	90	4000	
35824	OS-H5D-WW-RST-W-P1	5950	49	60	3000	
35856	OS-H8D-WW-RST-W-P1	5950	49	90	3000	
36080	OS-H5D-WN-RST-W-P1	6100	49	60	3000	
36096	OS-H8D-WN-RST-W-P1	6100	49	90	4000	
35840	OS-H5D-NW-RST-W-P1	6250	49	60	4000	
35872	OS-H8D-NW-RST-W-P1	6250	49	90	4000	
35952	OS-H5D-WW-RST-B-P1	5300	49	60	3000	
35984	OS-H8D-WW-RST-B-P1	5300	49	90	3000	
36144	OS-H5D-WN-RST-B-P1	5450	49	60	3000	
36160	OS-H8D-WN-RST-B-P1	5450	49	90	4000	
35968	OS-H5D-NW-RST-B-P1	5600	49	60	4000	
36000	OS-H8D-NW-RST-B-P1	5600	49	90	4000	

OS DALI RST P1 595x595mm



			lm	lm	°	W
BIAŁY	35876	OSD-S5D-WW-RST-W-P1	3050	23	60	3000
	35908	OSD-S8D-WW-RST-W-P1	3050	23	90	3000
	36100	OSD-S5D-WN-RST-W-P1	3150	23	60	3000
	36116	OSD-S8D-WN-RST-W-P1	3150	23	90	4000
	35892	OSD-S5D-NW-RST-W-P1	3250	23	60	4000
35924	OSD-S8D-NW-RST-W-P1	3250	23	90	4000	
36004	OSD-S5D-WW-RST-B-P1	2750	23	60	3000	
36036	OSD-S8D-WW-RST-B-P1	2750	23	90	3000	
36164	OSD-S5D-WN-RST-B-P1	2800	23	60	3000	
36180	OSD-S8D-WN-RST-B-P1	2800	23	90	4000	
36020	OSD-S5D-NW-RST-B-P1	2850	23	60	4000	
36052	OSD-S8D-NW-RST-B-P1	2850	23	90	4000	
35880	OSD-L5D-WW-RST-W-P1	4200	32	60	3000	
35912	OSD-L8D-WW-RST-W-P1	4200	32	90	3000	
36104	OSD-L5D-WN-RST-W-P1	4250	32	60	3000	
36120	OSD-L8D-WN-RST-W-P1	4250	32	90	4000	
35896	OSD-L5D-NW-RST-W-P1	4300	32	60	4000	
35928	OSD-L8D-NW-RST-W-P1	4300	32	90	4000	
36008	OSD-L5D-WW-RST-B-P1	3750	32	60	3000	
36040	OSD-L8D-WW-RST-B-P1	3750	32	90	3000	
36168	OSD-L5D-WN-RST-B-P1	3800	32	60	3000	
36184	OSD-L8D-WN-RST-B-P1	3800	32	90	4000	
36024	OSD-L5D-NW-RST-B-P1	3850	32	60	4000	
36056	OSD-L8D-NW-RST-B-P1	3850	32	90	4000	
35884	OSD-M5D-WW-RST-W-P1	5250	40	60	3000	
35916	OSD-M8D-WW-RST-W-P1	5250	40	90	3000	
36108	OSD-M5D-WN-RST-W-P1	5300	40	60	3000	
36124	OSD-M8D-WN-RST-W-P1	5300	40	90	4000	
35900	OSD-M5D-NW-RST-W-P1	5400	40	60	4000	
35932	OSD-M8D-NW-RST-W-P1	5400	40	90	4000	
36012	OSD-M5D-WW-RST-B-P1	4650	40	60	3000	
36048	OSD-M8D-WW-RST-B-P1	5300	50	90	3000	
36172	OSD-M5D-WN-RST-B-P1	4700	40	60	3000	
36188	OSD-M8D-WN-RST-B-P1	4700	40	90	4000	
36028	OSD-M5D-NW-RST-B-P1	4800	40	60	4000	
36060	OSD-M8D-NW-RST-B-P1	4800	40	90	4000	
35888	OSD-H5D-WW-RST-W-P1	5950	50	60	3000	
35920	OSD-H8D-WW-RST-W-P1	5950	50	90	3000	
36128	OSD-H5D-WN-RST-W-P1	6100	50	60	3000	
36144	OSD-H8D-WN-RST-W-P1	6100	50	90	4000	
35904	OSD-H5D-NW-RST-W-P1	6250	50	60	4000	
35936	OSD-H8D-NW-RST-W-P1	6250	50	90	4000	
36016	OSD-H5D-WW-RST-B-P1	5300	50	60	3000	
36044	OSD-M8D-WW-RST-B-P1	4650	40	90	3000	
36176	OSD-H5D-WN-RST-B-P1	5450	50	60	3000	
36192	OSD-H8D-WN-RST-B-P1	5450	50	90	4000	
36032	OSD-H5D-NW-RST-B-P1	5600	50	60	4000	
36064	OSD-H8D-NW-RST-B-P1	5600	50	90	4000	

Kanlux OFIS LED RST N3

OS RST N3 1200x300mm



			l_m	N	α	
BIAŁY	35811	OS-S5D-WW-RST-W-N3	3050	22	60	3000
	35843	OS-S8D-WW-RST-W-N3	3050	22	90	3000
	36067	OS-S5D-WN-RST-W-N3	3150	22	60	3000
	36083	OS-S8D-WN-RST-W-N3	3150	22	90	4000
	35827	OS-S5D-NW-RST-W-N3	3250	22	60	4000
35859	OS-S8D-NW-RST-W-N3	3250	22	90	4000	
35939	OS-S5D-WW-RST-B-N3	2750	22	60	3000	
35971	OS-S8D-WW-RST-B-N3	2750	22	90	3000	
36131	OS-S5D-WN-RST-B-N3	2800	22	60	3000	
36147	OS-S8D-WN-RST-B-N3	2800	22	90	4000	
35955	OS-S5D-NW-RST-B-N3	2850	22	60	4000	
35987	OS-S8D-NW-RST-B-N3	2850	22	90	4000	
35815	OS-L5D-WW-RST-W-N3	4200	31	60	3000	
35847	OS-L8D-WW-RST-W-N3	4200	31	90	3000	
36071	OS-L5D-WN-RST-W-N3	4250	31	60	3000	
36087	OS-L8D-WN-RST-W-N3	4250	31	90	4000	
35831	OS-L5D-NW-RST-W-N3	4300	31	60	4000	
35863	OS-L8D-NW-RST-W-N3	4300	31	90	4000	
35943	OS-L5D-WW-RST-B-N3	3750	31	60	3000	
35975	OS-L8D-WW-RST-B-N3	3750	31	90	3000	
36135	OS-L5D-WN-RST-B-N3	3800	31	60	3000	
36151	OS-L8D-WN-RST-B-N3	3800	31	90	4000	
35959	OS-L5D-NW-RST-B-N3	3850	31	60	4000	
35991	OS-L8D-NW-RST-B-N3	3850	31	90	4000	
35819	OS-M5D-WW-RST-W-N3	5250	39	60	3000	
35851	OS-M8D-WW-RST-W-N3	5250	39	90	3000	
36075	OS-M5D-WN-RST-W-N3	5300	39	60	3000	
36091	OS-M8D-WN-RST-W-N3	5300	39	90	4000	
35835	OS-M5D-NW-RST-W-N3	5400	39	60	4000	
35867	OS-M8D-NW-RST-W-N3	5400	39	90	4000	
35947	OS-M5D-WW-RST-B-N3	4650	39	60	3000	
35979	OS-M8D-WW-RST-B-N3	4650	39	90	3000	
36139	OS-M5D-WN-RST-B-N3	4700	39	60	3000	
36155	OS-M8D-WN-RST-B-N3	4700	39	90	4000	
35963	OS-M5D-NW-RST-B-N3	4800	39	60	4000	
35995	OS-M8D-NW-RST-B-N3	4800	39	90	4000	
35823	OS-H5D-WW-RST-W-N3	5950	49	60	3000	
35855	OS-H8D-WW-RST-W-N3	5950	49	90	3000	
36079	OS-H5D-WN-RST-W-N3	6100	49	60	3000	
36095	OS-H8D-WN-RST-W-N3	6100	49	90	4000	
35839	OS-H5D-NW-RST-W-N3	6250	49	60	4000	
35871	OS-H8D-NW-RST-W-N3	6250	49	90	4000	
35951	OS-H5D-WW-RST-B-N3	5300	49	60	3000	
35983	OS-H8D-WW-RST-B-N3	5300	49	90	3000	
36143	OS-H5D-WN-RST-B-N3	5450	49	60	3000	
36095	OS-H8D-WN-RST-B-N3	6100	49	90	4000	
35967	OS-H5D-NW-RST-B-N3	5600	49	60	4000	
35999	OS-H8D-NW-RST-B-N3	5600	49	90	4000	

OS DALI RST N3 1200x300mm



			l_m	N	α	
BIAŁY	35875	OSD-S5D-WW-RST-W-N3	3050	23	60	3000
	35907	OSD-S8D-WW-RST-W-N3	3050	23	90	3000
	36099	OSD-S5D-WN-RST-W-N3	3150	23	60	3000
	36115	OSD-S8D-WN-RST-W-N3	3150	23	90	4000
	35891	OSD-S5D-NW-RST-W-N3	3250	23	60	4000
35923	OSD-S8D-NW-RST-W-N3	3250	23	90	4000	
36003	OSD-S5D-WW-RST-B-N3	2750	23	60	3000	
36035	OSD-S8D-WW-RST-B-N3	2750	23	90	3000	
36019	OSD-S5D-WN-RST-B-N3	2850	23	60	4000	
36163	OSD-S5D-WN-RST-B-N3	2800	23	60	3000	
36179	OSD-S8D-WN-RST-B-N3	2800	23	90	4000	
36051	OSD-S8D-NW-RST-B-N3	2850	23	90	4000	
35879	OSD-L5D-WW-RST-W-N3	4200	32	60	3000	
35911	OSD-L8D-WW-RST-W-N3	4200	32	90	3000	
36103	OSD-L5D-WN-RST-W-N3	4250	32	60	3000	
36119	OSD-L8D-WN-RST-W-N3	4250	32	90	4000	
35895	OSD-L5D-NW-RST-W-N3	4300	32	60	4000	
35927	OSD-L8D-NW-RST-W-N3	4300	32	90	4000	
36007	OSD-L5D-WW-RST-B-N3	3750	32	60	3000	
36039	OSD-L8D-WW-RST-B-N3	3750	32	90	3000	
36167	OSD-L5D-WN-RST-B-N3	3800	32	60	3000	
36183	OSD-L8D-WN-RST-B-N3	3800	32	90	4000	
36023	OSD-L5D-NW-RST-B-N3	3850	32	60	4000	
36055	OSD-L8D-NW-RST-B-N3	3850	32	90	4000	
35883	OSD-M5D-WW-RST-W-N3	5250	40	60	3000	
35915	OSD-M8D-WW-RST-W-N3	5250	40	90	3000	
36107	OSD-M5D-WN-RST-W-N3	5300	40	60	3000	
36123	OSD-M8D-WN-RST-W-N3	5300	40	90	4000	
35899	OSD-M5D-NW-RST-W-N3	5400	40	60	4000	
35931	OSD-M8D-NW-RST-W-N3	5400	40	90	4000	
36011	OSD-M5D-WW-RST-B-N3	4650	40	60	3000	
36043	OSD-M8D-WW-RST-B-N3	4650	40	90	3000	
36171	OSD-M5D-WN-RST-B-N3	4700	40	60	3000	
36187	OSD-M8D-WN-RST-B-N3	4700	40	90	4000	
36027	OSD-M5D-NW-RST-B-N3	4800	40	60	4000	
36059	OSD-M8D-NW-RST-B-N3	4800	40	90	4000	
35887	OSD-H5D-WW-RST-W-N3	5950	50	60	3000	
35919	OSD-H8D-WW-RST-W-N3	5950	50	90	3000	
36111	OSD-H5D-WN-RST-W-N3	6100	50	60	3000	
36127	OSD-H8D-WN-RST-W-N3	6100	50	90	4000	
35903	OSD-H5D-NW-RST-W-N3	6250	50	60	4000	
35935	OSD-H8D-NW-RST-W-N3	6250	50	90	4000	
36015	OSD-H5D-WW-RST-B-N3	5300	50	60	3000	
36047	OSD-H8D-WW-RST-B-N3	5300	50	90	3000	
36175	OSD-H5D-WN-RST-B-N3	5450	50	60	3000	
36191	OSD-H8D-WN-RST-B-N3	5450	50	90	4000	
36031	OSD-H5D-NW-RST-B-N3	5600	50	60	4000	
36063	OSD-H8D-NW-RST-B-N3	5600	50	90	4000	

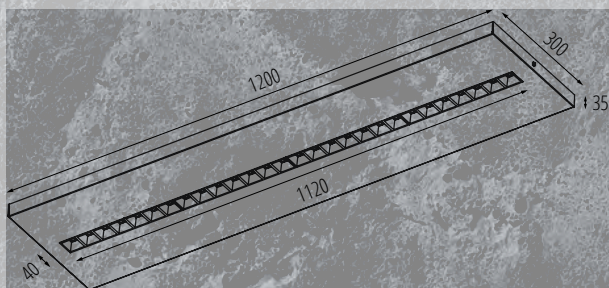

Kanlux OFIS LED RST P3

OS RST P3 1190x295mm



BIAŁY	35813	OS-S5D-WW-RST-W-P3	3050	22	60	3000	
	35845	OS-S8D-WW-RST-W-P3	3050	22	90	3000	
	36069	OS-S5D-WN-RST-W-P3	3150	22	60	3000	
	36085	OS-S8D-WN-RST-W-P3	3150	22	90	4000	
	35829	OS-S5D-NW-RST-W-P3	3250	22	60	4000	
35861	OS-S8D-NW-RST-W-P3	3250	22	90	4000		
35941	OS-S5D-WW-RST-B-P3	2750	22	60	3000		
35973	OS-S8D-WW-RST-B-P3	2750	22	90	3000		
36133	OS-S5D-WN-RST-B-P3	2800	22	60	3000		
36149	OS-S8D-WN-RST-B-P3	2800	22	90	4000		
35957	OS-S5D-NW-RST-B-P3	2850	22	60	4000		
35989	OS-S8D-NW-RST-B-P3	2850	22	90	4000		
35817	OS-L5D-WW-RST-W-P3	4200	31	60	3000		
35849	OS-L8D-WW-RST-W-P3	4200	31	90	3000		
36073	OS-L5D-WN-RST-W-P3	4250	31	60	3000		
36089	OS-L8D-WN-RST-W-P3	4250	31	90	4000		
35833	OS-L5D-NW-RST-W-P3	4300	31	60	4000		
35865	OS-L8D-NW-RST-W-P3	4300	31	90	4000		
35945	OS-L5D-WW-RST-B-P3	3750	31	60	3000		
35977	OS-L8D-WW-RST-B-P3	3750	31	90	3000		
36137	OS-L5D-WN-RST-B-P3	3800	31	60	3000		
36153	OS-L8D-WN-RST-B-P3	3800	31	90	4000		
35961	OS-L5D-NW-RST-B-P3	3850	31	60	4000		
35993	OS-L8D-NW-RST-B-P3	3850	31	90	4000		
35821	OS-M5D-WW-RST-W-P3	5250	39	60	3000		
35853	OS-M8D-WW-RST-W-P3	5250	39	90	3000		
36077	OS-M5D-WN-RST-W-P3	5300	39	60	3000		
36093	OS-M8D-WN-RST-W-P3	5300	39	90	4000		
35837	OS-M5D-NW-RST-W-P3	5400	39	60	4000		
35869	OS-M8D-NW-RST-W-P3	5400	39	90	4000		
35949	OS-M5D-WW-RST-B-P3	4650	39	60	3000		
35981	OS-M8D-WW-RST-B-P3	4650	39	90	3000		
36141	OS-M5D-WN-RST-B-P3	4700	39	60	3000		
36157	OS-M8D-WN-RST-B-P3	4700	39	90	4000		
35965	OS-M5D-NW-RST-B-P3	4800	39	60	4000		
35997	OS-M8D-NW-RST-B-P3	4800	39	90	4000		
35825	OS-H5D-WW-RST-W-P3	5950	49	60	3000		
35857	OS-H8D-WW-RST-W-P3	5950	49	90	3000		
36081	OS-H5D-WN-RST-W-P3	6100	49	60	3000		
36097	OS-H8D-WN-RST-W-P3	6100	49	90	4000		
35841	OS-H5D-NW-RST-W-P3	6250	49	60	4000		
35873	OS-H8D-NW-RST-W-P3	6250	49	90	4000		
35953	OS-H5D-WW-RST-B-P3	5300	49	60	3000		
35985	OS-H8D-WW-RST-B-P3	5300	49	90	3000		
36145	OS-H5D-WN-RST-B-P3	5450	49	60	3000		
36161	OS-H8D-WN-RST-B-P3	5450	49	90	4000		
35969	OS-H5D-NW-RST-B-P3	5600	49	60	4000		
36001	OS-H8D-NW-RST-B-P3	5600	49	90	4000		

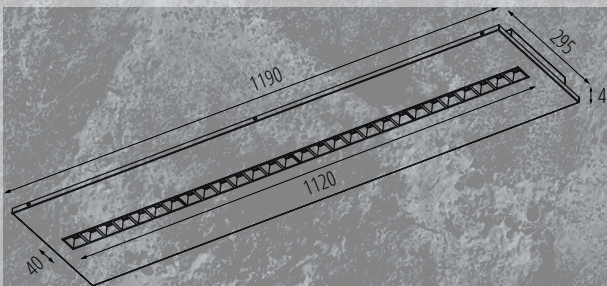
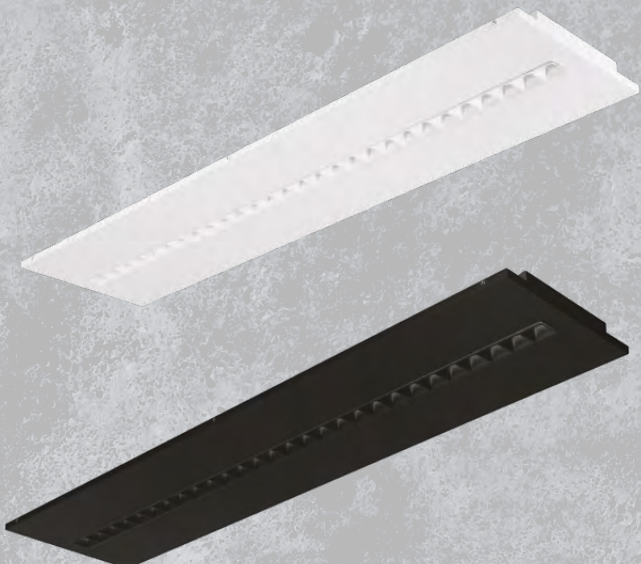

OS DALI RST P3 1190x295mm



BIAŁY	35877	OSD-S5D-WW-RST-W-P3	3050	23	60	3000	
	35909	OSD-S8D-WW-RST-W-P3	3050	23	90	3000	
	36101	OSD-S5D-WN-RST-W-P3	3150	23	60	3000	
	36117	OSD-S8D-WN-RST-W-P3	3150	23	90	4000	
	35893	OSD-S5D-NW-RST-W-P3	3250	23	60	4000	
35925	OSD-S8D-NW-RST-W-P3	3250	23	90	4000		
36005	OSD-S5D-WW-RST-B-P3	2750	23	60	3000		
36037	OSD-S8D-WW-RST-B-P3	2750	23	90	3000		
36165	OSD-S5D-WN-RST-B-P3	2800	23	60	3000		
36181	OSD-S8D-WN-RST-B-P3	2800	23	90	4000		
36021	OSD-S5D-NW-RST-B-P3	2850	23	60	4000		
36053	OSD-S8D-NW-RST-B-P3	2850	23	90	4000		
35881	OSD-L5D-WW-RST-W-P3	4200	32	60	3000		
35913	OSD-L8D-WW-RST-W-P3	4200	32	90	3000		
36105	OSD-L5D-WN-RST-W-P3	4250	32	60	3000		
36121	OSD-L8D-WN-RST-W-P3	4250	32	90	4000		
35897	OSD-L5D-NW-RST-W-P3	4300	32	60	4000		
35929	OSD-L8D-NW-RST-W-P3	4300	32	90	4000		
36009	OSD-L5D-WW-RST-B-P3	3750	32	60	3000		
36041	OSD-L8D-WW-RST-B-P3	3750	32	90	3000		
36169	OSD-L5D-WN-RST-B-P3	3800	32	60	3000		
36185	OSD-L8D-WN-RST-B-P3	3800	32	90	4000		
36025	OSD-L5D-NW-RST-B-P3	3850	32	60	4000		
36057	OSD-L8D-NW-RST-B-P3	3850	32	90	4000		
35885	OSD-M5D-WW-RST-W-P3	5250	40	60	3000		
35917	OSD-M8D-WW-RST-W-P3	5250	40	90	3000		
36109	OSD-M5D-WN-RST-W-P3	5300	40	60	3000		
36125	OSD-M8D-WN-RST-W-P3	5300	40	90	4000		
35901	OSD-M5D-NW-RST-W-P3	5400	40	60	4000		
35933	OSD-M8D-NW-RST-W-P3	5400	40	90	4000		
36013	OSD-M5D-WW-RST-B-P3	4650	40	60	3000		
36045	OSD-M8D-WW-RST-B-P3	4650	40	90	3000		
36173	OSD-M5D-WN-RST-B-P3	4700	40	60	3000		
36189	OSD-M8D-WN-RST-B-P3	4700	40	90	4000		
36029	OSD-M5D-NW-RST-B-P3	4800	40	60	4000		
36061	OSD-M8D-NW-RST-B-P3	4800	40	90	4000		
35889	OSD-H5D-WW-RST-W-P3	5950	50	60	3000		
35921	OSD-H8D-WW-RST-W-P3	5950	50	90	3000		
36113	OSD-H5D-WN-RST-W-P3	6100	50	60	3000		
36129	OSD-H8D-WN-RST-W-P3	6100	50	90	4000		
35905	OSD-H5D-NW-RST-W-P3	6250	50	60	4000		
35937	OSD-H8D-NW-RST-W-P3	6250	50	90	4000		
36017	OSD-H5D-WW-RST-B-P3	5300	50	60	3000		
36049	OSD-H8D-WW-RST-B-P3	5300	50	90	3000		
36177	OSD-H5D-WN-RST-B-P3	5450	50	60	3000		
36193	OSD-H8D-WN-RST-B-P3	5450	50	90	4000		
36033	OSD-H5D-NW-RST-B-P3	5600	50	60	4000		
36065	OSD-H8D-NW-RST-B-P3	5600	50	90	4000		

Kanlux OFIS LED RX P1

OS RX P1 595x595mm



BIAŁY	37180	OS-S8D-WW-RX-W-P1	3050	22	80	3000K
	37181	OS-L8D-WW-RX-W-P1	4200	31	80	3000K
	37182	OS-M8D-WW-RX-W-P1	5250	40	80	3000K
	37183	OS-H8D-WW-RX-W-P1	5950	47	80	3000K
	37184	OS-S8D-WN-RX-W-P1	3150	22	80	3500K
	37185	OS-L8D-WN-RX-W-P1	4300	31	80	3500K
	37186	OS-M8D-WN-RX-W-P1	5400	40	80	3500K
	37187	OS-H8D-WN-RX-W-P1	6100	47	80	3500K
	37188	OS-S8D-NW-RX-W-P1	3250	22	80	4000K
	37189	OS-L8D-NW-RX-W-P1	4400	31	80	4000K
CZARNY	37190	OS-M8D-NW-RX-W-P1	5500	40	80	4000K
	37191	OS-H8D-NW-RX-W-P1	6250	47	80	4000K
	37192	OS-S8D-WW-RX-B-P1	2750	22	80	3000K
	37193	OS-L8D-WW-RX-B-P1	3750	31	80	3000K
	37194	OS-M8D-WW-RX-B-P1	4650	40	80	3000K
	37195	OS-H8D-WW-RX-B-P1	5300	47	80	3000K
	37196	OS-S8D-WN-RX-B-P1	2800	22	80	3500K
	37197	OS-L8D-WN-RX-B-P1	3850	31	80	3500K
	37198	OS-M8D-WN-RX-B-P1	4800	40	80	3500K
	37199	OS-H8D-WN-RX-B-P1	5450	47	80	3500K
37200	OS-S8D-NW-RX-B-P1	2850	22	80	4000K	
37201	OS-L8D-NW-RX-B-P1	3900	31	80	4000K	
37202	OS-M8D-NW-RX-B-P1	4900	40	80	4000K	
37203	OS-H8D-NW-RX-B-P1	5600	47	80	4000K	

OS DALI RX P1 595x595mm



BIAŁY	37204	OSD-S8D-WW-RX-W-P1	3050	22	80	3000K
	37208	OSD-S8D-WN-RX-W-P1	3150	22	80	3500K
	37212	OSD-S8D-NW-RX-W-P1	3250	22	80	4000K
	37205	OSD-L8D-WW-RX-W-P1	4200	31	80	3000K
	37209	OSD-L8D-WN-RX-W-P1	4300	31	80	3500K
	37213	OSD-L8D-NW-RX-W-P1	4400	31	80	4000K
	37206	OSD-M8D-WW-RX-W-P1	5250	40	80	3000K
	37210	OSD-M8D-WN-RX-W-P1	5400	40	80	3500K
	37214	OSD-M8D-NW-RX-W-P1	5500	40	80	4000K
	37207	OSD-H8D-WW-RX-W-P1	5950	47	80	3000K
CZARNY	37211	OSD-H8D-WN-RX-W-P1	6100	47	80	3500K
	37215	OSD-H8D-NW-RX-W-P1	6250	47	80	4000K
	37216	OSD-S8D-WW-RX-B-P1	2750	22	80	3000K
	37220	OSD-S8D-WN-RX-B-P1	2800	22	80	3500K
	37224	OSD-S8D-NW-RX-B-P1	2850	22	80	4000K
	37217	OSD-L8D-WW-RX-B-P1	3750	31	80	3000K
	37221	OSD-L8D-WN-RX-B-P1	3850	31	80	3500K
	37225	OSD-L8D-NW-RX-B-P1	3900	31	80	4000K
	37218	OSD-M8D-WW-RX-B-P1	4650	40	80	3000K
	37222	OSD-M8D-WN-RX-B-P1	4800	40	80	3500K
37226	OSD-M8D-NW-RX-B-P1	4900	40	80	4000K	
37219	OSD-H8D-WW-RX-B-P1	5300	47	80	3000K	
37223	OSD-H8D-WN-RX-B-P1	5450	47	80	3500K	
37227	OSD-H8D-NW-RX-B-P1	5600	47	80	4000K	

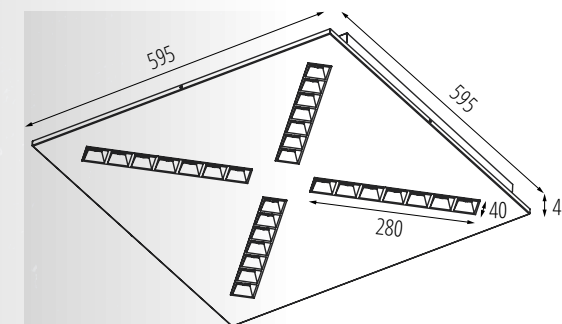
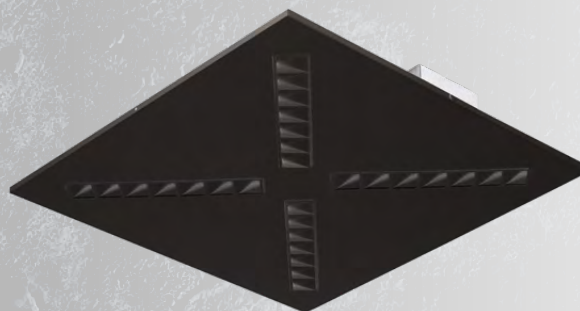
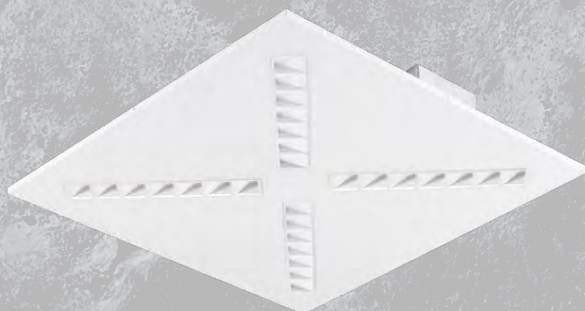

Kanlux



kanlux.com