

HIERRO

линейно LED осветително тяло









 [V] 220-240 AC	 [Hz] 50	 ≥ 30000	 [h] 50000	 ellipse $\leq 6^\circ$ MacAdam	 Ra 80	 SMD
 DALI	 ⊕	 IP 20		 [°C] 5÷25		
 [mm] 0,5÷2,5		 0,5m				



HRD-LL-WW-W-NT

HIERRO

линейно LED осветително тяло

							
	[W]	Tc [K]	TYPE	[°]		[lm]	[mm]
HRD-LL-WW-W-NT	36991	23	3000	растер	X60/Y60	бял	3000 850
HRD-LM-WW-W-NT	36992	32	3000	растер	X60/Y60	бял	4000 850
HRD-LH-WW-W-NT	36993	42	3000	растер	X60/Y60	бял	4950 850
HRD-LL-WW-B-NT	36997	23	3000	растер	X60/Y60	черен	2650 850
HRD-LM-WW-B-NT	36998	32	3000	растер	X60/Y60	черен	3550 850
HRD-LH-WW-B-NT	36999	42	3000	растер	X60/Y60	черен	4350 850
HRD-LL-WN-W-NT	37003	23	3500	растер	X60/Y60	бял	3050 850
HRD-LM-WN-W-NT	37004	32	3500	растер	X60/Y60	бял	4100 850
HRD-LH-WN-W-NT	37005	42	3500	растер	X60/Y60	бял	5050 850
HRD-LL-WN-B-NT	37009	23	3500	растер	X60/Y60	черен	2700 850
HRD-LM-WN-B-NT	37010	32	3500	растер	X60/Y60	черен	3650 850
HRD-LH-WN-B-NT	37011	42	3500	растер	X60/Y60	черен	4500 850
HRD-LL-NW-W-NT	37015	23	4000	растер	X60/Y60	бял	3150 850
HRD-LM-NW-W-NT	37016	32	4000	растер	X60/Y60	бял	4200 850
HRD-LH-NW-W-NT	37017	42	4000	растер	X60/Y60	бял	5150 850
HRD-LL-NW-B-NT	37021	23	4000	растер	X60/Y60	черен	2800 850
HRD-LM-NW-B-NT	37022	32	4000	растер	X60/Y60	черен	3750 850
HRD-LH-NW-B-NT	37023	42	4000	растер	X60/Y60	черен	4600 850

- Материал на корпуса: стомана, пластмаса
- Материал на дифузера: пластмаса



HIERRO

линейно LED осветително тяло



HRD-LL-WW-W-NT



HRD-LM-WW-W-NT



HRD-LH-WW-W-NT



HRD-LL-WW-B-NT



HRD-LM-WW-B-NT



HRD-LH-WW-B-NT



HRD-LL-WN-W-NT



HRD-LM-WN-W-NT



HRD-LH-WN-W-NT



HRD-LL-WN-B-NT



HRD-LM-WN-B-NT



HRD-LH-WN-B-NT



HRD-LL-NW-W-NT



HRD-LM-NW-W-NT



HRD-LH-NW-W-NT



HRD-LL-NW-B-NT

HIERRO

линейно LED осветително тяло



HRD-LM-NW-B-NT



HRD-LH-NW-B-NT

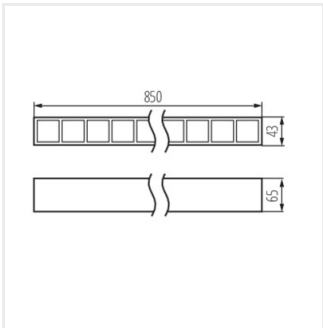

HRD-LH-NT

