

HIERRO

Lineární LED svítidlo









 [V] 220-240 AC	 [Hz] 50	 ≥ 30000	 [h] 50000	 + Ellipse $\leq 6x$ MacAdam	 Ra 80	 SMD
 DALI		 IP 20		 [°C] 5÷25		
 [mm] 0,5÷2,5		 0,5m				



HRD-L-W-PT

HIERRO

Lineární LED svítidlo

							
	[W]	Tc [K]	TYPE	[°]		[lm]	[mm]
HRD-LL-WW-W-PT	37075	23	3000	rastr	X60/Y60	bílá	3000 875
HRD-LM-WW-W-PT	37076	32	3000	rastr	X60/Y60	bílá	4000 875
HRD-LH-WW-W-PT	37077	42	3000	rastr	X60/Y60	bílá	4950 875
HRD-LL-WW-B-PT	37081	23	3000	rastr	X60/Y60	černá	2650 875
HRD-LM-WW-B-PT	37082	32	3000	rastr	X60/Y60	černá	3550 875
HRD-LH-WW-B-PT	37083	42	3000	rastr	X60/Y60	černá	4350 875
HRD-LL-WN-W-PT	37087	23	3500	rastr	X60/Y60	bílá	3050 875
HRD-LM-WN-W-PT	37088	32	3500	rastr	X60/Y60	bílá	4100 875
HRD-LH-WN-W-PT	37089	42	3500	rastr	X60/Y60	bílá	5050 875
HRD-LL-WN-B-PT	37093	23	3500	rastr	X60/Y60	černá	2700 875
HRD-LM-WN-B-PT	37094	32	3500	rastr	X60/Y60	černá	3650 875
HRD-LH-WN-B-PT	37095	42	3500	rastr	X60/Y60	černá	4500 875
HRD-LL-NW-W-PT	37099	23	4000	rastr	X60/Y60	bílá	3150 875
HRD-LM-NW-W-PT	37100	32	4000	rastr	X60/Y60	bílá	4200 875
HRD-LH-NW-W-PT	37101	42	4000	rastr	X60/Y60	bílá	5150 875
HRD-LL-NW-B-PT	37105	23	4000	rastr	X60/Y60	černá	2800 875
HRD-LM-NW-B-PT	37106	32	4000	rastr	X60/Y60	černá	3750 875
HRD-LH-NW-B-PT	37107	42	4000	rastr	X60/Y60	černá	4600 875

HIERRO je řada svítidel vyráběných v továrně Kanlux. Minimalistická a elegantní forma zapadá do nejnovějších trendů v architektonickém designu. Stylové řešení je široce používáno v moderních kancelářích, obchodech a půdních prostorech jako základní, doplňkové nebo akcentové osvětlení. Velkými výhodami svítidel HIERRO jsou: rozmanitost dostupných způsobů ovládání a instalace, nízký koeficient UGR, vysoká světelná účinnost, schopnost přizpůsobení konkrétním projektům osvětlení a 5letá záruka. To vám umožní vytvářet energeticky úsporné a moderní osvětlovací systémy, které poskytují atraktivní světelné efekty.

- Materiál korpusu: ocel, plast
- Materiál difuzoru: plast



HIERRO

Lineární LED svítidlo



HRD-L-W-PT



HRD-L-B-PT

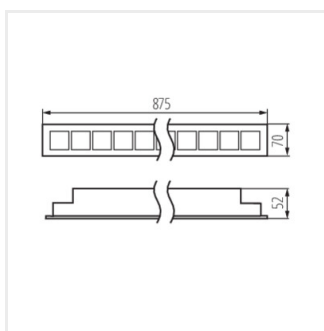

HRD-L-PT

