

HIERRO

Luminaire profilés linéaire LED









 220-240 AC	 50	 ≥30000	 50000	 Ra 80	
		 IP 20		 5÷25	
 1,5÷2,5		 0,5m			



HR-LL-WW-W-NT

HIERRO

Luminaire profilés linéaire LED

								
HR-LL-WW-W-NT	36945	23	3000	grille	X60/Y60	blanc	3000	850
HR-LM-WW-W-NT	36946	32	3000	grille	X60/Y60	blanc	4000	850
HR-LH-WW-W-NT	36947	42	3000	grille	X60/Y60	blanc	4950	850
HR-LL-WW-B-NT	36953	23	3000	grille	X60/Y60	noir	2650	850
HR-LM-WW-B-NT	36954	32	3000	grille	X60/Y60	noir	3550	850
HR-LH-WW-B-NT	36955	42	3000	grille	X60/Y60	noir	4350	850
HR-LL-WN-W-NT	36961	23	3500	grille	X60/Y60	blanc	3050	850
HR-LM-WN-W-NT	36962	32	3500	grille	X60/Y60	blanc	4100	850
HR-LH-WN-W-NT	36963	42	3500	grille	X60/Y60	blanc	5050	850
HR-LL-WN-B-NT	36969	23	3500	grille	X60/Y60	noir	2700	850
HR-LM-WN-B-NT	36970	32	3500	grille	X60/Y60	noir	3650	850
HR-LH-WN-B-NT	36971	42	3500	grille	X60/Y60	noir	4500	850
HR-LL-NW-W-NT	36977	23	4000	grille	X60/Y60	blanc	3150	850
HR-LM-NW-W-NT	36978	32	4000	grille	X60/Y60	blanc	4200	850
HR-LH-NW-W-NT	36979	42	4000	grille	X60/Y60	blanc	5150	850
HR-LL-NW-B-NT	36985	23	4000	grille	X60/Y60	noir	2800	850
HR-LM-NW-B-NT	36986	32	4000	grille	X60/Y60	noir	3750	850
HR-LH-NW-B-NT	36987	42	4000	grille	X60/Y60	noir	4600	850

HIERRO est une famille de luminaires fabriqués dans l'usine Kanlux. La forme minimaliste et élégante s'inscrit dans les dernières tendances de la décoration. Cette solution élégante peut être utilisée dans les bureaux, les magasins et les espaces de type loft en tant qu'éclairage de base, d'appoint ou d'accentuation. Les grands avantages des luminaires HIERRO sont la diversité des options de contrôle et de montage disponibles, le faible UGR, l'efficacité lumineuse élevée, la possibilité de personnalisation pour des projets d'éclairage spécifiques et la garantie de 5 ans. Il est ainsi possible de créer des systèmes d'éclairage modernes et efficaces sur le plan énergétique, qui produisent des effets lumineux intéressants.

- Matériau du boîtier: acier, matériau plastique
- Matériau du diffuseur: matériau plastique



HIERRO

Luminaire profilés linéaire LED



HR-LL-WW-W-NT



HR-LM-WW-W-NT



HR-LH-WW-W-NT



HR-LL-WW-B-NT



HR-LM-WW-B-NT



HR-LH-WW-B-NT



HR-LL-WN-W-NT



HR-LM-WN-W-NT



HR-LH-WN-W-NT



HR-LL-WN-B-NT



HR-LM-WN-B-NT



HR-LH-WN-B-NT



HR-LL-NW-W-NT



HR-LM-NW-W-NT



HR-LH-NW-W-NT



HR-LL-NW-B-NT

HIERRO

Luminaire profilés linéaire LED



HR-LM-NW-B-NT



HR-LH-NW-B-NT

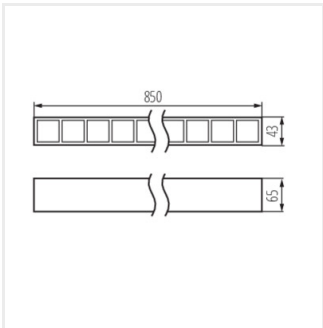

HR-LH-NT

