

## HIERRO

### Luminaire profilés linéaire LED









 220-240 AC	 50	 ≥30000	 50000	 ≤6x MacAdam	 80	 SMD
		 IP 20		 5÷25		 0,5m



HR-LL-WW-W-RM

## HIERRO

### Luminaire profilés linéaire LED

								
		Tc [K]		TYPE	[°]		[lm]	[mm]
HR-LL-WW-W-RM	<b>37112</b>	23	3000	grille	X60/Y60	blanc	3000	850
HR-LM-WW-W-RM	<b>37113</b>	32	3000	grille	X60/Y60	blanc	4000	850
HR-LH-WW-W-RM	<b>37114</b>	42	3000	grille	X60/Y60	blanc	4950	850
HR-LL-WW-B-RM	<b>37119</b>	23	3000	grille	X60/Y60	noir	2650	850
HR-LM-WW-B-RM	<b>37120</b>	32	3000	grille	X60/Y60	noir	3550	850
HR-LH-WW-B-RM	<b>37121</b>	42	3000	grille	X60/Y60	noir	4350	850
HR-LL-WN-W-RM	<b>37126</b>	23	3500	grille	X60/Y60	blanc	3050	850
HR-LM-WN-W-RM	<b>37127</b>	32	3500	grille	X60/Y60	blanc	4100	850
HR-LH-WN-W-RM	<b>37128</b>	42	3500	grille	X60/Y60	blanc	5050	850
HR-LL-WN-B-RM	<b>37133</b>	23	3500	grille	X60/Y60	noir	2700	850
HR-LM-WN-B-RM	<b>37134</b>	32	3500	grille	X60/Y60	noir	3650	850
HR-LH-WN-B-RM	<b>37135</b>	42	3500	grille	X60/Y60	noir	4500	850
HR-LL-NW-W-RM	<b>37140</b>	23	4000	grille	X60/Y60	blanc	3150	850
HR-LM-NW-W-RM	<b>37141</b>	32	4000	grille	X60/Y60	blanc	4200	850
HR-LH-NW-W-RM	<b>37142</b>	42	4000	grille	X60/Y60	blanc	5150	850
HR-LL-NW-B-RM	<b>37147</b>	23	4000	grille	X60/Y60	noir	2800	850
HR-LM-NW-B-RM	<b>37148</b>	32	4000	grille	X60/Y60	noir	3750	850
HR-LH-NW-B-RM	<b>37149</b>	42	4000	grille	X60/Y60	noir	4600	850

HIERRO est une famille de luminaires fabriqués dans l'usine Kanlux. La forme minimaliste et élégante s'inscrit dans les dernières tendances de la décoration. Cette solution élégante peut être utilisée dans les bureaux, les magasins et les espaces de type loft en tant qu'éclairage de base, d'appoint ou d'accentuation. Les grands avantages des luminaires HIERRO sont la diversité des options de contrôle et de montage disponibles, le faible UGR, l'efficacité lumineuse élevée, la possibilité de personnalisation pour des projets d'éclairage spécifiques et la garantie de 5 ans. Il est ainsi possible de créer des systèmes d'éclairage modernes et efficaces sur le plan énergétique, qui produisent des effets lumineux intéressants.

- Matériau du boîtier: acier, matériau plastique
- Matériau du diffuseur: matériau plastique

## HIERRO

Luminaire profilés linéaire LED



HR-LL-WW-W-RM



HR-LM-WW-W-RM



HR-LH-WW-W-RM



HR-LL-WW-B-RM



HR-LM-WW-B-RM



HR-LH-WW-B-RM



HR-LL-WN-W-RM



HR-LM-WN-W-RM

## HIERRO

### Luminaire profilés linéaire LED



HR-LH-WN-W-RM



HR-LL-WN-B-RM



HR-LM-WN-B-RM



HR-LH-WN-B-RM



HR-LL-NW-W-RM



HR-LM-NW-W-RM



HR-LH-NW-W-RM



HR-LL-NW-B-RM



HR-LM-NW-B-RM



HR-LH-NW-B-RM

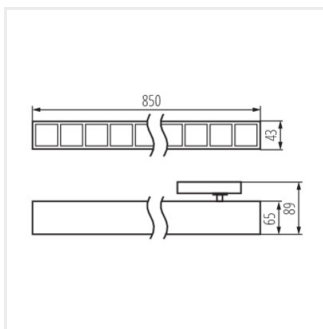

HR-LH\_RM

## HIERRO

Luminaire profilés linéaire LED

