

FUTURIO LED DALI 43W 1480mm

Plafoniera stagna led



[V] 220-240 AC	[Hz] 50	≥30000	50000	ellipse ≤3x MacAdam	Ra 80	SMD
DALI		IP 65			IK 08	
[mm ²] 0,5+2,5	0,5m	CE	EAC	PZH	UK CA	



FTD1500 43W-840-OPL

	[V]	Tc [K]		TYPE	[°]	[lm]	lm W	[mm]	[°C]
FTD1500 43W-840-OPL	28862	43	4000	opalescente	X130/Y110	6100	142	1480	-25÷40
FTD1500 43W-840-RYF	28863	43	4000	grooved	X115/Y105	6500	151	1480	-25÷40
FTD1500 43W-840-INT	28864	43	4000	prismatico, a fascio stretto	X70/Y95	6300	147	1480	-25÷40
FTD1500 43W-840-ASY	28865	43	4000	prismatico, asimmetrico	X75/Y95	6300	147	1480	-25÷40

- 5 anni di garanzia secondo le condizioni della dichiarazione di garanzia consultabile sul sito Internet
- Materiale del corpo: PC
- Materiale del diffusore: PC



FTD1500 43W-840-OPL



FTD1500 43W-840-RYF



FTD1500 43W-840-INT



FTD1500 43W-840-ASY

FUTURIO LED DALI 43W 1480mm

Plafoniera stagna led

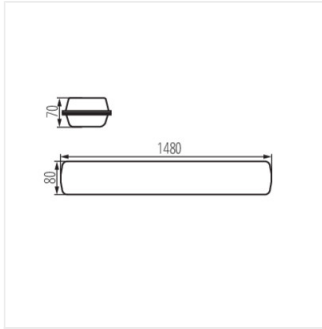

FTD1500 43W-840-OPL

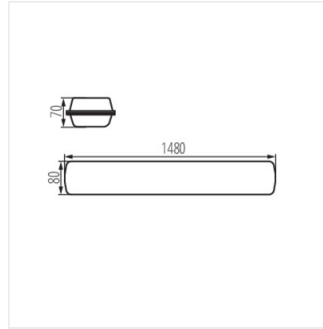

FTD1500 43W-840-RYF

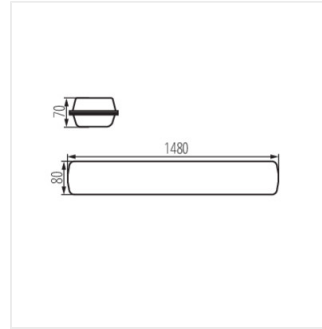

FTD1500 43W-840-INT

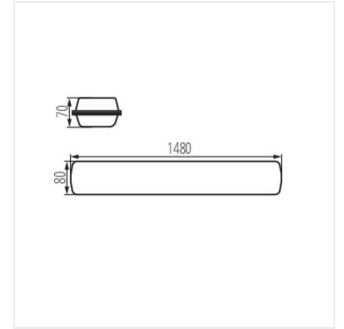

FTD1500 43W-840-ASY