

Kanlux



Kanlux XLED C35

Kanlux XLED combina le migliori caratteristiche delle lampade tradizionali con le più moderne lampadine LED. La versione con la classica forma di candela diffonde la luce in modo ampio e uniforme raggiungendo i 320° di rifrazione!















HIGH
lumen

up to

150 $\frac{\text{lm}}{\text{W}}$



XLED C35E14 2,5W

 220-240 AC	 50	 FILAMENT	 360° Φ _{use}	 ellipse ≤ 6x MacAdam	 Ra 80	 15000
						



XLED C35E14 2,5W-WW	29617	2,5	25	250	2700	320	E14	≥15000	F
XLED C35E14 4,5W-WW	29618	4,5	40	470	2700	320	E14	≥15000	F
XLED C35E14 4,5W-NW	29619	4,5	40	470	4000	320	E14	≥15000	F
XLED C35 E14 6W-WW	35272	6	60	806	2700	320	E14	≥25000	E
XLED C35 E14 6W-NW	35273	6	60	806	4000	320	E14	≥25000	E
XLED C35E14 7W-WW	38416	7	75	1055	2700	320	E14	≥25000	D
XLED C35E14 7W-NW	38417	7	75	1055	4000	320	E14	≥25000	D
XLED C35E14 7W-CW	38418	7	75	1055	6500	320	E14	≥25000	D



XLED C35E14 2,5W



XLED C35E14 4,5W



XLED C35E14 4,5W-NW



XLED C35 E14 6W-WW



XLED C35 E14 6W-NW



XLED C35E14 7W-WW



XLED C35E14 7W-NW



XLED C35E14 7W-CW

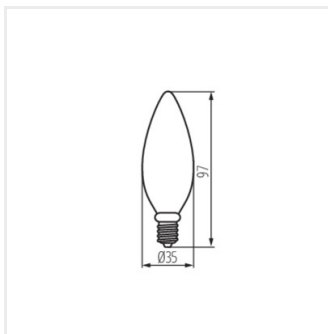

XLED C35 E14

Data di emissione: 14.11.2024, 09:54

Ci riserviamo la possibilità di introdurre delle modifiche tecniche. I dati contenuti in questo materiale non sono legalmente vincolanti.

Fotometria: risultati conseguiti durante l'esame di una singola unità del prodotto.

