

Kanlux



Kanlux AL-ML-NT

Kanlux ALIN LED to oprawy, które powstały z myślą o oświetleniu idealnym. Stworzyli je projektanci Kanlux, którzy połączyli innowację z ponad 30 letnim doświadczeniem. Markowe komponenty i perfekcyjne wykonanie zapewniają estetykę i trwałość działania opraw Kanlux ALIN przez długie lata.



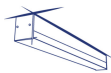



- 5 lat Gwarancji na warunkach oświadczenia gwarancyjnego, dostępnego na stronie internetowej



| | | | | | | |
|----------------|--------|--------------|-----------|----------------------------|--------|--|
| 220-240 AC | 50 | ≥30000 | 50000 | ellipse ≤3x Nachdam | 80 | |
| | | IP 20 | | 5÷25 | | |
| 1,5÷2,5 | | 0,5m | | | | |



AL-ML-MAT-B-NT

| | |  |  |  |  |  |  |  |
|---------------------|-----------------------|--|--|--|---|--|--|--|
| AL-ML-NW-MAT-B-NT | 33984 | 25 | 4000 | matowy | X85/Y95 | czarny | 3250 | 1140 |
| AL-ML-NW-MAT-S-NT | 33996 | 25 | 4000 | matowy | X85/Y95 | srebrny | 3250 | 1140 |
| AL-ML-NW-MAT-W-NT | 33972 | 25 | 4000 | matowy | X85/Y95 | biały | 3250 | 1140 |
| AL-ML-NW-MPR-B-NT | 33988 | 25 | 4000 | mikropryzmatyczny | X75/Y90 | czarny | 3000 | 1140 |
| AL-ML-NW-MPR-S-NT | 34000 | 25 | 4000 | mikropryzmatyczny | X75/Y90 | srebrny | 3000 | 1140 |
| AL-ML-NW-MPR-W-NT | 33976 | 25 | 4000 | mikropryzmatyczny | X75/Y90 | biały | 3000 | 1140 |
| AL-ML-NW-RST-B-NT | 33992 | 25 | 4000 | raster | X85/Y85 | czarny | 3400 | 1140 |
| AL-ML-NW-RST-W-NT | 33980 | 25 | 4000 | raster | X85/Y85 | biały | 3850 | 1140 |
| AL-ML-WW-MAT-B-NT | 33986 | 25 | 3000 | matowy | X85/Y95 | czarny | 2980 | 1140 |
| AL-ML-WW-MAT-S-NT | 33998 | 25 | 3000 | matowy | X85/Y95 | srebrny | 2980 | 1140 |
| AL-ML-WW-MAT-W-NT | 33974 | 25 | 3000 | matowy | X85/Y95 | biały | 2980 | 1140 |
| AL-ML-WW-MPR-B-NT | 33990 | 25 | 3000 | mikropryzmatyczny | X75/Y90 | czarny | 2750 | 1140 |
| AL-ML-WW-MPR-S-NT | 34002 | 25 | 3000 | mikropryzmatyczny | X75/Y90 | srebrny | 2750 | 1140 |
| AL-ML-WW-MPR-W-NT | 33978 | 25 | 3000 | mikropryzmatyczny | X75/Y90 | biały | 2750 | 1140 |
| AL-ML-WW-RST-B-NT | 33994 | 25 | 3000 | raster | X85/Y85 | czarny | 3250 | 1140 |
| AL-ML-WW-RST-W-NT | 33982 | 25 | 3000 | raster | X85/Y85 | biały | 3650 | 1140 |
| AL-ML5D-NW-RST-B-NT | 37572 | 25 | 4000 | raster | X60/Y60 | czarny | 3400 | 1140 |
| AL-ML5D-NW-RST-W-NT | 37573 | 25 | 4000 | raster | X60/Y60 | biały | 3850 | 1140 |
| AL-ML5D-WW-RST-B-NT | 37574 | 25 | 3000 | raster | X60/Y60 | czarny | 3250 | 1140 |
| AL-ML5D-WW-RST-W-NT | 37575 | 25 | 3000 | raster | X60/Y60 | biały | 3650 | 1140 |



AL-ML-MAT-B-NT



AL-ML-MAT-W-NT



AL-ML-MAT-S-NT



AL-ML-MPR-B-NT



AL-ML-MPR-W-NT



AL-ML-MPR-S-NT



AL-ML-RST-B-NT



AL-ML-RST-W-NT

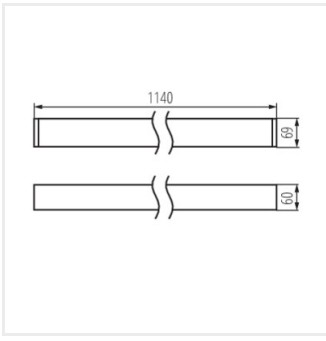

AL-ML-NT

Akcesoria

32540

ALIN CORD 1F-W

Przyłącze zasilające do opraw i linii ALIN, 1 fazowe, białe, 150cm



32541

ALIN CORD 1F-B

Przyłącze zasilające do opraw i linii ALIN, 1 fazowe, czarne, 150cm



32542

ALIN CORD 1F-SR

Przyłącze zasilające do opraw i linii ALIN, 1 fazowe, srebrne, 150cm



07871

ROPE-NT 150 SINGLE

ROPE-NT 150 SINGLE (pojedyncza) linka stalowa do zwieszania opraw, 2 szt w komplecie



29557

ALIN NT GRIP

Uchwyt ścienny do oprawy ALIN, 2 szt w komplecie



25979

KLOSZ MPR AL 23W/33W

Klosz MPR do oprawy ALIN, KLOSZ MPR AL 23W/33W, (25979)

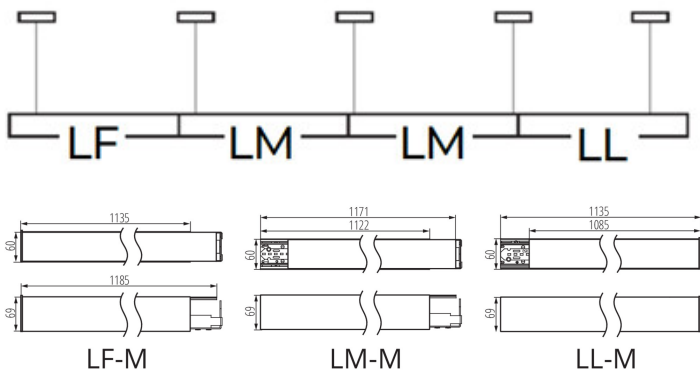
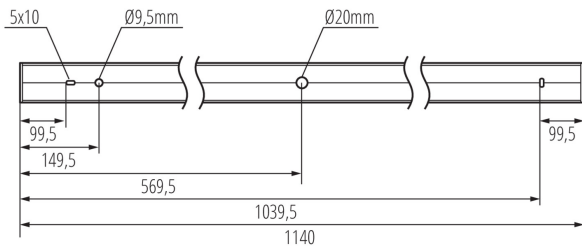
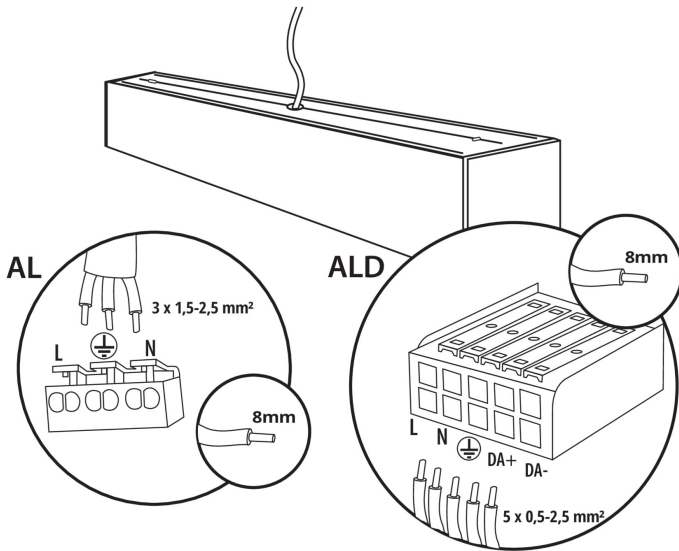

Dokument utworzono: 10.10.2024, 07:47

Zastrzega się możliwość wprowadzenia zmian technicznych. Dane zawarte w tym katalogu nie są prawnie wiążące. Fotometria: wyniki uzyskane podczas badania konkretnego egzemplarza.

