

## HIERRO

Corp de iluminat liniar LED









 [V] 220-240 AC	 [Hz] 50	 $\geq 30000$	 [h] 50000	 ellipse $\leq 6x$ MacAdam	 Ra 80	 SMD
 DALI	 ⊕	 IP 20		 [°C] 5÷25		
 [mm] 0,5÷2,5		 0,5m				



HRD-LL-WW-W-NT

## HIERRO

### Corp de iluminat liniar LED

								
HRD-LL-WW-W-NT	<b>36991</b>	23	3000	raster	X60/Y60	alb	3000	850
HRD-LM-WW-W-NT	<b>36992</b>	32	3000	raster	X60/Y60	alb	4000	850
HRD-LH-WW-W-NT	<b>36993</b>	42	3000	raster	X60/Y60	alb	4950	850
HRD-LL-WW-B-NT	<b>36997</b>	23	3000	raster	X60/Y60	negru	2650	850
HRD-LM-WW-B-NT	<b>36998</b>	32	3000	raster	X60/Y60	negru	3550	850
HRD-LH-WW-B-NT	<b>36999</b>	42	3000	raster	X60/Y60	negru	4350	850
HRD-LL-WN-W-NT	<b>37003</b>	23	3500	raster	X60/Y60	alb	3050	850
HRD-LM-WN-W-NT	<b>37004</b>	32	3500	raster	X60/Y60	alb	4100	850
HRD-LH-WN-W-NT	<b>37005</b>	42	3500	raster	X60/Y60	alb	5050	850
HRD-LL-WN-B-NT	<b>37009</b>	23	3500	raster	X60/Y60	negru	2700	850
HRD-LM-WN-B-NT	<b>37010</b>	32	3500	raster	X60/Y60	negru	3650	850
HRD-LH-WN-B-NT	<b>37011</b>	42	3500	raster	X60/Y60	negru	4500	850
HRD-LL-NW-W-NT	<b>37015</b>	23	4000	raster	X60/Y60	alb	3150	850
HRD-LM-NW-W-NT	<b>37016</b>	32	4000	raster	X60/Y60	alb	4200	850
HRD-LH-NW-W-NT	<b>37017</b>	42	4000	raster	X60/Y60	alb	5150	850
HRD-LL-NW-B-NT	<b>37021</b>	23	4000	raster	X60/Y60	negru	2800	850
HRD-LM-NW-B-NT	<b>37022</b>	32	4000	raster	X60/Y60	negru	3750	850
HRD-LH-NW-B-NT	<b>37023</b>	42	4000	raster	X60/Y60	negru	4600	850

- Materialul carcasei: oțel, material din plastic
- Materialul abajurului: material din plastic



## HIERRO

### Corp de iluminat liniar LED



HRD-LL-WW-W-NT



HRD-LM-WW-W-NT



HRD-LH-WW-W-NT



HRD-LL-WW-B-NT



HRD-LM-WW-B-NT



HRD-LH-WW-B-NT



HRD-LL-WN-W-NT



HRD-LM-WN-W-NT



HRD-LH-WN-W-NT



HRD-LL-WN-B-NT



HRD-LM-WN-B-NT



HRD-LH-WN-B-NT



HRD-LL-NW-W-NT



HRD-LM-NW-W-NT



HRD-LH-NW-W-NT



HRD-LL-NW-B-NT

## HIERRO

### Corp de iluminat liniar LED



HRD-LM-NW-B-NT



HRD-LH-NW-B-NT

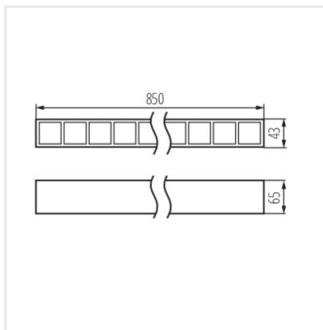

HRD-LH-NT

