

HIERRO

Corp de iluminat liniar LED









 220-240 AC	 50	 ≥30000	 50000	 Ra 80	
 DALI		 IP 20		 5÷25	
 0,5÷2,5		 0,5m			



HRD-LL-WW-W-PT

HIERRO

Corp de iluminat liniar LED

							
HRD-LL-WW-W-PT 37075	23	3000	raster	X60/Y60	alb	3000	875
HRD-LM-WW-W-PT 37076	32	3000	raster	X60/Y60	alb	4000	875
HRD-LH-WW-W-PT 37077	42	3000	raster	X60/Y60	alb	4950	875
HRD-LL-WW-B-PT 37081	23	3000	raster	X60/Y60	negru	2650	875
HRD-LM-WW-B-PT 37082	32	3000	raster	X60/Y60	negru	3550	875
HRD-LH-WW-B-PT 37083	42	3000	raster	X60/Y60	negru	4350	875
HRD-LL-WN-W-PT 37087	23	3500	raster	X60/Y60	alb	3050	875
HRD-LM-WN-W-PT 37088	32	3500	raster	X60/Y60	alb	4100	875
HRD-LH-WN-W-PT 37089	42	3500	raster	X60/Y60	alb	5050	875
HRD-LL-WN-B-PT 37093	23	3500	raster	X60/Y60	negru	2700	875
HRD-LM-WN-B-PT 37094	32	3500	raster	X60/Y60	negru	3650	875
HRD-LH-WN-B-PT 37095	42	3500	raster	X60/Y60	negru	4500	875
HRD-LL-NW-W-PT 37099	23	4000	raster	X60/Y60	alb	3150	875
HRD-LM-NW-W-PT 37100	32	4000	raster	X60/Y60	alb	4200	875
HRD-LH-NW-W-PT 37101	42	4000	raster	X60/Y60	alb	5150	875
HRD-LL-NW-B-PT 37105	23	4000	raster	X60/Y60	negru	2800	875
HRD-LM-NW-B-PT 37106	32	4000	raster	X60/Y60	negru	3750	875
HRD-LH-NW-B-PT 37107	42	4000	raster	X60/Y60	negru	4600	875

- Materialul carcasei: oțel, material din plastic
- Materialul abajurului: material din plastic

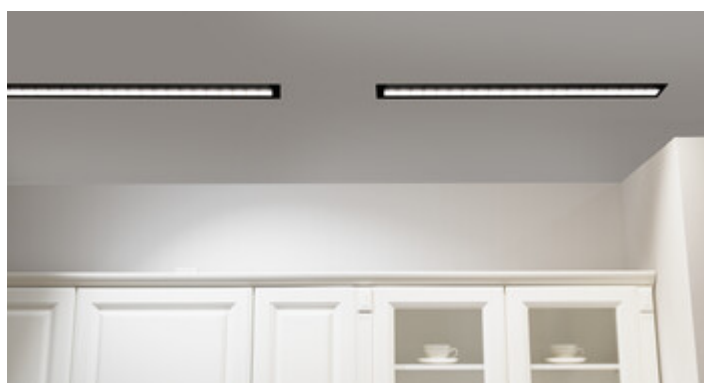

HIERRO

Corp de iluminat liniar LED



HRD-LL-WW-W-PT



HRD-LM-WW-W-PT



HRD-LH-WW-W-PT



HRD-LL-WW-B-PT



HRD-LM-WW-B-PT



HRD-LH-WW-B-PT



HRD-LL-WN-W-PT



HRD-LM-WN-W-PT



HRD-LH-WN-W-PT



HRD-LL-WN-B-PT



HRD-LM-WN-B-PT



HRD-LH-WN-B-PT



HRD-LL-NW-W-PT



HRD-LM-NW-W-PT



HRD-LH-NW-W-PT



HRD-LL-NW-B-PT

HIERRO

Corp de iluminat liniar LED



HRD-LM-NW-B-PT



HRD-LH-NW-B-PT

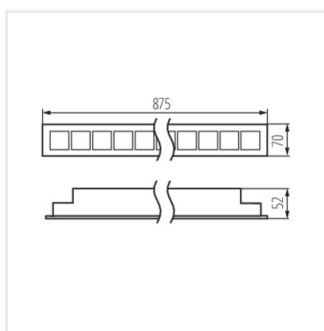

HRD-L-PT

