

HIERRO

Lineárne LED svietidlo









 [V] 220-240 AC	 [Hz] 50	 ≥ 30000	 [h] 50000	 + ellipse $\leq 6x$ MacAdam	 Ra 80	 SMD
 DALI		 IP 20		 [°C] 5÷25		
 [mm] 0,5÷2,5		 0,5m				



HRD-L-W-PT

HIERRO

Lineárne LED svietidlo

							
	[W]	Tc [K]	TYPE	[°]		[mm]	
HRD-LL-WW-W-PT	37075	23	3000	raster	X60/Y60	biela	3000 875
HRD-LM-WW-W-PT	37076	32	3000	raster	X60/Y60	biela	4000 875
HRD-LH-WW-W-PT	37077	42	3000	raster	X60/Y60	biela	4950 875
HRD-LL-WW-B-PT	37081	23	3000	raster	X60/Y60	čierna	2650 875
HRD-LM-WW-B-PT	37082	32	3000	raster	X60/Y60	čierna	3550 875
HRD-LH-WW-B-PT	37083	42	3000	raster	X60/Y60	čierna	4350 875
HRD-LL-WN-W-PT	37087	23	3500	raster	X60/Y60	biela	3050 875
HRD-LM-WN-W-PT	37088	32	3500	raster	X60/Y60	biela	4100 875
HRD-LH-WN-W-PT	37089	42	3500	raster	X60/Y60	biela	5050 875
HRD-LL-WN-B-PT	37093	23	3500	raster	X60/Y60	čierna	2700 875
HRD-LM-WN-B-PT	37094	32	3500	raster	X60/Y60	čierna	3650 875
HRD-LH-WN-B-PT	37095	42	3500	raster	X60/Y60	čierna	4500 875
HRD-LL-NW-W-PT	37099	23	4000	raster	X60/Y60	biela	3150 875
HRD-LM-NW-W-PT	37100	32	4000	raster	X60/Y60	biela	4200 875
HRD-LH-NW-W-PT	37101	42	4000	raster	X60/Y60	biela	5150 875
HRD-LL-NW-B-PT	37105	23	4000	raster	X60/Y60	čierna	2800 875
HRD-LM-NW-B-PT	37106	32	4000	raster	X60/Y60	čierna	3750 875
HRD-LH-NW-B-PT	37107	42	4000	raster	X60/Y60	čierna	4600 875

HIERRO je rad svietidiel vyrábaných v továrni Kanlux. Minimalistická a elegantná forma zapadá do najnovších trendov v architektonickom dizajne. Štýlové riešenie je široko používané v moderných kanceláriách, obchodoch a podkrovných priestoroch ako základné, doplnkové alebo akcentové osvetlenie. Veľkými výhodami svietidiel HIERRO sú: rozmanitosť dostupných spôsobov ovládania a inštalácie, nízky koeficient UGR, vysoká svetelná účinnosť, schopnosť prispôbenia konkrétnym projektom osvetlenia a 5-ročná záruka. To vám umožní vytvárať energeticky úsporné a moderné osvetľovacie systémy, ktoré poskytujú atraktívne svetelné efekty.

- Materiál korpusu: oceľ, plast
- Materiál difúzora: plast



HIERRO

Lineárne LED svietidlo



HRD-L-W-PT



HRD-L-B-PT

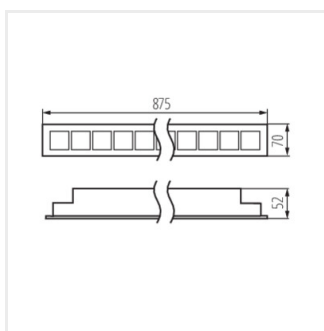

HRD-L-PT

